



People's and Democratic Republic of Algeria
Ministry of Higher Education and Scientific Research
Med Khider University of Biskra



Faculty of Exact Sciences and Natural and Life Sciences

Department Of Science Of Matter

THESIS

Presented to obtain the degree of
Doctorate

Specialty: Physics of matter

Behavior of the wave solutions under the effect of the nonlinearity

Comportements des solutions des ondes sous l'effet de la non linéarité

Presented by:

Warda Djoudi

Board of Examiners

Pr. A. Attaf	Prof	University Med Khider of Biskra	Chairman
Pr. A. Zerarka	Prof	University Med Khider of Biskra	Supervisor
Pr. A. Gueddin	Prof	University Ziane Achour Djelfa	Examiner
Pr. N. Attaf	Prof	University of Constantine 1	Examiner
Dr. N. Khelil	MC	University Med Khider of Biskra	Examiner
Dr. H. Saidi	MC	University Med Khider of Biskra	Examiner

Academic Year: 2017-2018

Dedications

Foremost, I would like to thank my family: my parents for their love and support throughout my life and to my brothers, nephews and to my sister for supporting me spiritually throughout writing this thesis and my life in general. To all my friends, thank you for your understanding and encouragement in many moments of crisis. your friendship makes my life a wonderful experience.

Thank you.

إلى من أضاء بعلمه عقل غيره..... وأهدى بالجواب الصحيح حيرة سائليه

فأظهر بسماحته تواضع العلماء..... ووبرحابته سماحة العارفين.

Acknowledgments

Firstly, I would like to express my sincere gratitude to my advisor Professor. **A. Zerarka** for the continuous support of my PhD and master study and related research, for his patience, motivation, and immense knowledge. His guidance helped me in all the time of research and writing of this thesis. I am grateful to my advisor for enlightening me the first glance of research. I could not have imagined having a better advisor and mentor for my PhD study.

Besides my advisor, I would like to thank the rest of my thesis committee: Prof. **A. Attaf**, Prof. **A. Gueddim**, Prof. **N. Attaf**, Dr. **N. Khelil** and Dr. **H. Saidi**, for their insightful comments, encouragement and hard questions.

Last but not the least; I would like to thank all the administrative staff and professors of the Faculty of Exact Sciences and Applied Mathematics Laboratory and all the Colleagues.

Table of Contents

List of figures

General introduction	1
-----------------------------------	---

Chapter 1

Some methods to solve the lattice differential equation	4
1.1 Introduction	4
1.2 The nonlinear lattice differential–difference equations (NDDEs)	4
1.2.1 A new expanded method for solving nonlinear differential–difference equation	6
1.2.2 The non–linear lattice equation.....	8
1.3 Discussion and conclusion.....	20
References	22

Chapter 2

Exact fractional solutions of nonlinear lattice equation via some fractional transformation methods.....	29
2.1 Introduction	29
2.2 Applications.....	31
2.3 The fractional transformation methods	32
2.4 Discussion and conclusion.....	47
References	49

Chapter 3

Symbolic computational of nonlinear wave equation with constant coefficients via the functional variable method.....	51
3.1 Introduction	51

3.2	Formulation of the method.....	51
3.3	Application.....	53
3.3.1	Benjamin-Bona-Mahony (BBM) equation.....	54
3.3.2	Equation Benjamin-Bona-Mahony (BBM) with negative exponents.....	60
3.3.3	A generalized form of the BBM equation.....	66
3.3.4	A generalized form of the BBM equation with negative exponents.....	69
3.4	Discussions.....	75
3.5	Conclusion.....	75
	References.....	77

Chapter 4

	Exact solutions for the KdV–mKdV equation with time– dependent coefficients using the modified functional variable method.....	81
4.1	Introduction.....	81
4.2	Description of the method fvm.....	82
4.3	KdV–mKdV solutions.....	84
4.4	Partial structures.....	85
4.5	Full structures.....	86
4.6	Conclusion.....	91
	References.....	93
	General conclusion.....	96

List of figures

Figure 1.1 $u_n(t) = u^\pm(\zeta_n)$ in (1.26) and $\beta = 4, \alpha = 1, d = 1$ and $\zeta_0 = 0$ 12	
Figure 1.2 Plot 3D representation of $u_n[n, t] = u^+[\xi_n]$ and $\alpha = 1,$ $\beta = 4, d = 1, \zeta_0 = 0$ 17	17
Figure 1.3 Plot 2D representation of $u_n[n, t] = u^+[\xi_n]$ and $\alpha = 1,$ $\beta = 4, d = 1, \zeta_0 = 0$ 17	17
Figure 2.1 Plot 3D representation of $u_n[n, t] = u^+[\xi_n]$ and α $= 1, \beta = 4, d = 1$ and $\zeta_0 = 0, j = -0.5$ 34	34
Figure 2.2 Plot 2D representation of $u_n[n, t] = u^+[\xi_n]$ and $\alpha = 1,$ $\beta = 4, d = 1$ and $\zeta_0 = 0, j = -0.5$ 34	34
Figure 2.3 Plot 3D representation of $u_n[n, t] = u^+[\xi_n]$ and $\alpha = 1,$ $\beta = 4, d = 1$ and $\zeta_0 = 0$ 37	37
Figure 2.4 Plot 2D representation of $u_n[n, t] = u^+[\xi_n]$ and $\alpha = 1, \beta$ $= 4, d = 1$ and $\zeta_0 = 0$ 37	37
Figure 2.5 Plot 3D representation of $u_n[n, t] = u^-[\xi_n]$ and $\alpha = 4,$ $\beta = 1, d = 1$ and $\zeta_0 = 0$ 39	39
Figure 2.6 Plot 2D representation of $u_n[n, t] = u^-[\xi_n]$ and $\alpha = 4,$ $\beta = 1, d = 1$ and $\zeta_0 = 0$ 40	40
Figure 2.7 Plot 3D representation of $u_n[n, t] = u^+[\xi_n]$ and $\alpha = 4,$ $\beta = 1, d = 1$ and $\zeta_0 = 0$ 41	41
Figure 2.8 Plot 3D representation of $u_n[n, t] = u^-[\xi_n]$ and $\alpha = 4,$ $\beta = 1, d = 1$ and $\zeta_0 = 0$ 42	42
Figure 2.9 Plot 3D representation of $u_n[n, t] = u^+[\xi_n]$ and $\alpha = 1,$ $\beta = 4, d = 1$ and $\zeta_0 = 0$ 45	45

Figure 2.10 Plot 3D representation of $u_n[n, t] = u^-\left[\xi_n\right]$ and $\alpha = 1$, $\beta = 4$, $d = 1$ and $\xi_0 = 0$	46
Figure 3.1 Plot 3D representation of Eq. (3.24) for both curves: $n = 4, m = 2, \alpha = 1, c = 1$ and $\xi_0 = 0$	58
Figure 3.2 Plot 2D representation of Eq. (3.24) and $n = 4, m = 2, \alpha = 1, c = 1$, and $\xi_0 = 0$	58
Figure 3.3 Plot 3D representation of Eq. (3.59) and $n = 4, m = 2, \alpha = -1, c = 1$, and $\xi_0 = 0$	66
Figure 3.4 Plot 2D representation of Eq. (3.59) and $n = 4, m = 2, \alpha = -1, c = 1$, and $\xi_0 = 0$	66
Figure 3.5 Plot 3D representation of Eq. (3.85) and $n = 5, m = 2, \alpha = 1, c = 2$ and $\xi_0 = 0$	73
Figure 3.6 Plot 2D representation of Eq. (3.85) and $n = 5, m = 2, \alpha = 1, c = 2$ and $\xi_0 = 0$	74
Figure 4.1 The graph shows the wave solution of $u_1(x, t) = U_1(\xi)$ in (4.24a). The curve was performed with the parameters $A = 1$, $\mu = 4$, $\lambda = 1$, $\nu = 3$, $\varepsilon = 1$, $q_{00} = \frac{4}{3}$, $q_{10} = 1$, $\alpha_0 = \sqrt{\frac{2}{3}}$, $\beta_0 = 0$, $h_0 = 4$, $h_1 = -2t$, $h_2 = -t$, $h_3 = \frac{2}{t}$, $h_4 = t^{-1}$	91
Figure 4.2 The evolution of the wave solution $u_4(x, t) = U_4(\xi)$ given by Eq. (4.24d), input parameters: $A = 1$, $\mu = 4$, $\lambda = 1$, $\nu = 4$, $\varepsilon = 1$, $q_{00} = \frac{4}{3}$, $q_{10} = 1$, $\alpha_0 = \sqrt{\frac{1}{2}}$, $\beta_0 = 0$, $h_0 = 4$, $h_1 = -2t$, $h_2 = -t$, $h_3 = \frac{2}{t}$, $h_4 = t^{-1}$	92

General introduction

This thesis is a part of scientific study for partial differential equations in physics and applied mathematics that has been developed in laboratory and supervised by Professor A. Zerarka. The investigation of the travelling waves solutions for nonlinear partial differential equations plays an important role in the study of nonlinear physical phenomena, where nonlinear wave phenomenon appears in various scientific and engineering fields, such as fluid mechanics, plasma physics, biology, solid state physics, chemical kinematics, chemical physics ,geochemistry and optical fibers. This later includes: nonlinear wave dispersion phenomena, dissipation, diffusion, reaction and convection which are very important in nonlinear wave equations.

New exact solutions may help us well to find new phenomena by using a variety of powerful methods, such as inverse scattering method [1,2], bilinear transformation [3], the tanh–sech method [4–6], extended tanh method [7–9], sine–cosine method [10,11], homogeneous balance method (HBM) [12]. The homogeneous balance method is a powerful tool to find solitary wave solutions from nonlinear partial differential equations (NPDEs) [13–16].

Although, the limited work which was done to symbolically compute exact solutions for nonlinear differential–difference equations (NDDEs)? However, NDDEs play an important role in numerical simulations of NPDEs; for example, queuing problems, and discretizations in solid state and quantum physics which go back to the work of Fermi, Pasta and Ulam in the 1950s [17]. Another example of higher importance in high energy physics is the systems in numerical simulation of soliton dynamics; where they arise as approximations of continuum models.

The nonlinear differential–difference equations (NDDEs) appear in different fields such as condensed matter physics, biophysics and mechanical engineering. Thus, the exact solutions for the nonlinear differential–difference equations (NDDEs) play a crucial role in the modeling of many phenomena; one of them is the

physical as particle vibrations in lattices, currents in electrical networks, pulses in biological chains, etc.

Nonlinear differential–difference equations (NDDEs) have been the focus of many nonlinear studies [18, 19]. There is a widely researchers' work on NDDEs. It includes investigations of integrability criteria, the computation of densities, generalized and master symmetries, and recursion operators [20]. Levi and colleagues [21, 22], Yamilov [23,24] and co-workers [25–30] that classify the NDDEs into canonical forms, integrability tests ,and connections between integrable NPDEs and NDDEs are analysis in detail. Considerable quantity of information about integrable NDDEs was provided by Suris in his articles [31–35] and his book [36]. Suris and other researchers have shown that many lattices are closely related to the Toda lattice [37],its relativistic counterpart due to Ruijsenaars [38], Baldwin [39] implemented the tanh–method, also sech, cn, and sn–methods in Mathematica, Liu and Li [40,41] implemented the tanh method in Maple.

With the rapid development of nonlinear science, scientists and engineers have been interested in the asymptotic analytical techniques for nonlinear problems. Although, it is very easy for us now to find solutions for linear systems by using the computer, it is always very difficult to solve nonlinear problems numerically or analytically. This is probably due to the fact that the various methods of numerical simulations apply to iteration techniques to find their numerical solutions to non–linear problems, and almost all iterative methods are sensitive to the initial solutions. Thus, it seems difficult to obtain consistent results in the case of strong nonlinearity. Other evolution equations in physics are completely integrated, but this unique aspect has the disadvantage of causing unstable disturbance for the equation; in the sense it does not allow the refinement of the physical modeling.

The objective of this work is to construct solutions for some physical models that are mathematically processed by using the method coth, coth–csch, the method of fractional transformations and the decomposition method of the functional variable; so we are going to proceed as follows:

- Presentation of new methods for solving nonlinear lattice equations.
- The application of functional variable methods to solve various nonlinear equations.
- Using homogeneous balance method to find precise and explicit solutions.

This thesis consists of a general introduction which presents the importance of theme, the objectives of the search and shows the outline of the thesis that contains four main chapters, and finally a general conclusion. In the first chapter, some methods to solve nonlinear lattice equation, where we address the method \coth and method $\coth\text{-csch}$ which has proved its effectiveness in solving nonlinear lattice equation are stated. In the second chapter, the nonlinear lattice equation is investigated with the aid of symbolic computation; we use some fractional transformations to obtain many types of new precise solutions. The third chapter contains a set of solutions for the generalized one-dimensional of the Benjamin-Bona-Mahony (BBM) equation for any order by using the function variable method. The last chapter proposes a method of functional variable applied on nonlinear problem with coefficients variable.

Chapter 1

Some methods to solve the lattice differential equation

1.1 Introduction

In this section we present some various methods to construct the travelling wave solutions of the non-linear lattice equation which it's among nonlinear differential-difference equations (NDDEs), where it is observed in many important scientific fields [42-49].

So, in this chapter we offer a new expanded method for solving nonlinear differential-difference equations, where we show its demonstration to get the travelling wave structures.

For comparing the wave solutions of non-linear equation, also we offer a strong and effective non-linear model is the tanh-method for solving the nonlinear lattice problem. This provides us with some new kink-type and bell-type travelling wave solutions with different forms.

In order to obtain new wave solutions for non-linear lattice equation, we will apply our new method called coth and coth-csch method. We expect that this method will provide deeper and more complete understanding of the complex structures of complicated nonlinear lattice equation of atom or molecule.

1.2 The nonlinear lattice differential-difference equations (NDDEs)

A differential equation is a mathematical equation that relates to some functions with their derivatives. In applications, the functions usually represent

physical quantities, the derivatives represent their rates of change, and the equation defines a relationship between the two. Such relations are extremely common.

Within differential equations the nonlinear differential equations which can exhibit very complicated behaviour over extended time intervals, characteristic of chaos. Even the fundamental questions of existence, uniqueness, and ability of extending solutions for nonlinear differential equations, were studied by Boyce, et al. (1967) [50], For searching those solutions we consider the following nonlinear problem for the differential equation

$$P(u_{n+l_1}(t), \dots, u_{n+l_m}(t), u'_{n+l_1}(t), \dots, u'_{n+l_m}(t), \dots, u_{n+l_1}^{(r)}(t), \dots, u_{n+l_m}^{(r)}(t)) = 0 \quad (1.1)$$

where P is a polynomial of u and its derivatives, $u_n(t) = u(n, t)$ is a function with continuous variable t and discrete variable $n \in \mathbb{Z}, l_i \in \mathbb{Z}, i = 1, 2, \dots, m$.

To find the traveling wave solutions of Eq. (1.1) we introduce the wave transformation:

$$\xi = \sum_{i=0}^p \alpha_i \chi_i + \xi_0, \quad (1.2)$$

χ_i are the independent variables, and ξ_0 and α_i are free parameters. When

$p = 1$, $\xi = \alpha_0 \chi_0 + \alpha_1 \chi_1 + \xi_0$, the parameters α_0, α_1 are identified as the wave pulsation ω and the wave number k respectively if χ_0, χ_1 are the variables t and x respectively. In the discrete case for the position x and with continuous variable for the time t , ξ becomes $\xi_n = nd + ct + \xi_0$ and n is the discrete variable d and ξ_0 are arbitrary constants.

We introduce the following transformation for a travelling wave solution of Eq. (1.1),

So that

$$u(n, t) = u(\xi) \quad (1.3)$$

where, ξ_0 is arbitrary constant and c is a parameter of wave speed to be determined later. Substituting (1.3) into (1.1), we can obtain an equivalent equation of (1.1):

$$\begin{aligned} & Q(u(\zeta_{n+l_1}), \dots, u(\zeta_{n+l_m}), u'(\zeta_{n+l_1}), \dots, u'(\zeta_{n+l_m}), \dots, \\ & u^{(r)}(\zeta_{n+l_1}), \dots, u^{(r)}(\zeta_{n+l_m})) = 0 \end{aligned} \quad (1.4)$$

1.2.1 A new expanded method for solving nonlinear differential–difference equation

To seek for the different solutions of NDDEs, it is important to include some mathematical transformations. So in this example, we would like to propose a new transformation called the expanded method, to find more closed–form solutions of NDDEs [51], where it treats the lattice equation introduced by Wadati 1976 [52] as following

$$\frac{du_n(t)}{dt} = (\alpha + \beta u_n(t) + \gamma u_n^2(t))(u_{n-1}(t) - u_{n+1}(t)) \quad (1.5)$$

Where α , β , γ are three parameters. This equation contains Hybrid lattice equation [53]. We seek for the traveling wave solutions of Eq. (1.4) as the following assumption:

$$u_n(t) = u(\xi_n) = \sum_{i=0}^k A_i f^i(\xi_n) + \sum_{j=1}^k B_j f^{-j}(\xi_n) + \sum_{m=1}^k J_m f^{m-1}(\xi_n) g(\xi_n) \quad (1.6)$$

With

$$\begin{cases} f(\xi_n) = \frac{\sinh(\xi_n)}{S \sinh(\xi_n) + \cosh(\xi_n)}, \\ g(\xi_n) = \frac{1}{S \sinh(\xi_n) + \cosh(\xi_n)}, \end{cases} \quad (1.7)$$

Where A_i, B_j, J_m, S are constants, one can easily get the degree $k = 1$ in Eq. (1.6) by balancing the highest nonlinear terms and the highest-order derivative term in Eq. (1.4). And therefore it gives us the following solutions which are formal travelling wave solutions of Eq. (1.5) .

$$u(\xi_n) = A_0 + \frac{A_1 \sinh(\xi_n)}{S \sinh(\xi_n) + \cosh(\xi_n)} + \frac{B_1(S \sinh(\xi_n) + \cosh(\xi_n))}{\sinh(\xi_n)} + \frac{J_1}{S \sinh(\xi_n) + \cosh(\xi_n)} \quad (1.8)$$

Where A_0, A_1, B_1, J_1, S are constants to be determined later. We have

$$\zeta_{n+p_i} = (n + p_i)d + ct + \zeta_0 = \zeta_n + dp_i, \quad (1.9)$$

and

$$\begin{aligned} \sinh(x \pm y) &= \sinh(x) \cosh(y) \pm \cosh(x) \sinh(y) \\ \cosh(x \pm y) &= \cosh(x) \cosh(y) \pm \sinh(x) \sinh(y) \end{aligned} \quad (1.10)$$

and

$$\sinh^2 x = \cosh^2 x - 1 \quad (1.11)$$

Substituting the Eq. (1.8) into Eq. (1.5), and using the identity Eq. (1.9) and Eq. (1.10) and Eq.(1.11), clearing the denominator and setting the coefficients of $\cosh^p(\zeta_n) \sinh^l(\zeta_n)$ ($p = 0, 1, \dots, 7; l = 0, 1$) to zero, and solve it with the aid of computer symbolic software Maple and, one can obtain the following periodic solutions

$$u_n(t) =: u^\pm(\zeta_n) = -\frac{\beta}{2\gamma} \pm \frac{\sqrt{\beta^2 - 4\alpha\gamma} \tan(d)}{2\gamma} \tan(\zeta_n) \quad (1.12)$$

and

$$u_n(t) =: u^\pm(\zeta_n) = -\frac{\beta}{2\gamma} \pm \frac{\sqrt{\beta^2 - 4\alpha\gamma} \tan(d)}{2\gamma} \cot(\zeta_n) \quad (1.13)$$

where

$$\zeta_n = nd + \frac{\beta^2 - 4\alpha\gamma}{2\gamma} \tan(d)t + \zeta_0$$

and

$$u_n(t) =: u^\pm(\zeta_n) = -\frac{\beta}{2\gamma} \pm \frac{\sqrt{\beta^2 - 4\alpha\gamma} \sin(2d)}{4\gamma} (\tan(\zeta_n) + \cot(\zeta_n)) \quad (1.14)$$

where

$$\zeta_n = nd + \frac{\beta^2 - 4\alpha\gamma}{4\gamma} \sin(2d)t + \zeta_0$$

and

$$u_n(t) =: u^\pm(\zeta_n) = -\frac{\beta}{2\gamma} \pm \frac{\sqrt{\beta^2 - 4\alpha\gamma} \tan(2d)}{4\gamma} (\tan(\zeta_n) - \cot(\zeta_n)) \quad (1.15)$$

where

$$\zeta_n = nd + \frac{\beta^2 - 4\alpha\gamma}{4\gamma} \tan(2d)t + \zeta_0$$

The periodic solutions (12) and (14) are completely in accordance with the solutions given by Xie [54], but the solutions (13) and (15) are given firstly.

Note:

The computation procedure shows that computer algebra plays an important role in exactly solving NDDEs, which includes several famous lattice.

1.2.2 The non-linear lattice equation

The solutions for nonlinear lattice equations are travelling wave solutions which describe the asymptotic behaviours and propagations of waves. So the types of solutions are very important. Thus, we choose nonlinear lattice equations to

illustrate the validity and advantages of the algorithm. In this study, we focus on the following types of nonlinear lattice equation [55–70].

$$\frac{du_n(t)}{dt} = \left(\alpha + \beta u_n(t) + u_n^2(t) \right) \left(u_{n+1}(t) - u_{n-1}(t) \right) \quad (1.16)$$

where α and β are constants and $u(t)$ is a displacement wave function with the continuous variable t (time) ; and which represents the solution of equation (1.16). For solving a big class of nonlinear equations, we present some of the following models.

1.2.2.1 The method of tanh

The tanh–function method, developed for a long time, is one of the most direct and effective algebraic method for finding the exact solutions of the nonlinear equations. We present a method tanh–function in reference [54] for the solutions of (1.1) as the form

$$u_n(t) = \sum_{i=0}^k A_i \tanh(\zeta_n) =: u(\zeta_n) \quad (1.17)$$

Using equation (1.17) in the system (1.1) We get Eq. (1.4), and for convenience purposes, we use $O\left(\frac{d^p u}{d\zeta_n^p}\right)$ to represent the highest order polynomial as we find

$$\begin{aligned} O\left(\frac{d^p u}{d\zeta_n^p}\right) &= k + p, p = 0, 1, 2, \dots \\ O\left(u^q \frac{d^p u}{d\zeta_n^p}\right) &= (q + 1)k + p, q, p = 0, 1, 2, \dots \end{aligned} \quad (1.18)$$

This is a homogeneous balance principle, since $\left(\frac{d^p u}{d\zeta_n^p}\right)$ it is a polynomial of $\tanh(\zeta_n)$ and $\operatorname{sech}(\zeta_n)$ and we have

$$\zeta_n + l_i = (n + l_i)d + ct + \zeta_0 = \zeta_n + dl, i = 1, 2, \dots, m, \quad (1.19)$$

and

$$\tanh^2(\zeta_n) + \operatorname{sech}^2(\zeta_n) = 1 \quad (1.20)$$

The algebraic equations (1.4) provide a system in which all coefficients c, A_0, \dots, A_k , in which all coefficients of $\tanh^i(\zeta_n)$ are cancelled. Therefore, solving the nonlinear algebraic system with the help of Mathematica for example, the final shape of the solution can be obtained.

1.2.2.2 The exact solutions of (1.16) for a case of physical interest

We notice that a different choice of forms of the exact traveling wave solutions can have its own advantage in applications. In what follows, we will concentrate on the applications and development of the tanh-function method.

The nonlinear physical system from (1.16) is as follows

$$cu'(\zeta_n) = (\alpha + \beta u(\zeta_n) + u^2(\zeta_n))(u(\zeta_{n+1}) - u(\zeta_{n-1})) \quad (1.21)$$

We now present six types of exact traveling wave solutions of Eq. (1.16) with the use of the method of the function $\tanh^i(\zeta_n)$.

Case 1: According to the homogeneous balance principle, where $k = 1$, Eq (1.17) becomes.

$$u(\zeta_n) = A_0 + A_1 \tanh(\zeta_n) \quad (1.22)$$

therefore

$$u(\zeta_{n+1}) = A_0 + \frac{A_1(\tanh(\zeta_n) + \tanh(d))}{1 + \tanh(\zeta_n)\tanh(d)} \quad (1.23)$$

$$u(\zeta_{n-1}) = A_0 + \frac{A_1(\tanh(\zeta_n) - \tanh(d))}{1 - \tanh(\zeta_n)\tanh(d)} \quad (1.24)$$

Substituting (1.22) - (1.24) in (1.21), and taking into account that the coefficients of $\tanh^i(\zeta_n)$, ($i = 0, 1, 2$) are zero, it follows a set of nonlinear algebraic equations for c , A_0 and A_1 :

$$\begin{cases} 2(\alpha + \beta A_0 + A_0^2)\tanh(d) - c = 0 \\ (2A_0 + \beta)\tanh(d) = 0 \\ 2A_1^2 + c\tanh(d) = 0 \end{cases} \quad (1.25)$$

This system provides the unknown coefficients

$$A_0 = -\frac{\beta}{2}, c = \frac{4\alpha - \beta^2}{2}\tanh(d), A_1 = \pm \frac{\sqrt{\beta^2 - 4\alpha}}{2}\tanh(d)$$

Thus the two kink soliton solutions (1.16) are obtained:

$$u_n(t) = -\frac{\beta}{2\gamma} \pm \frac{\sqrt{\beta^2 - 4\alpha\gamma}\tanh(d)}{2\gamma}\tanh(\zeta_n) \quad (1.26)$$

Where $\zeta_n = nd + \frac{4\alpha - \beta^2}{2}\tanh(d)t + \zeta_0$ and d, ζ_0 are arbitrary constants. The configurations of (1.26) are shown in Figure (1.1) where $u_n(t) =: u^+(\zeta_n)$ is on the left, and $u_n(t) =: u^-(\zeta_n)$ is on the right.

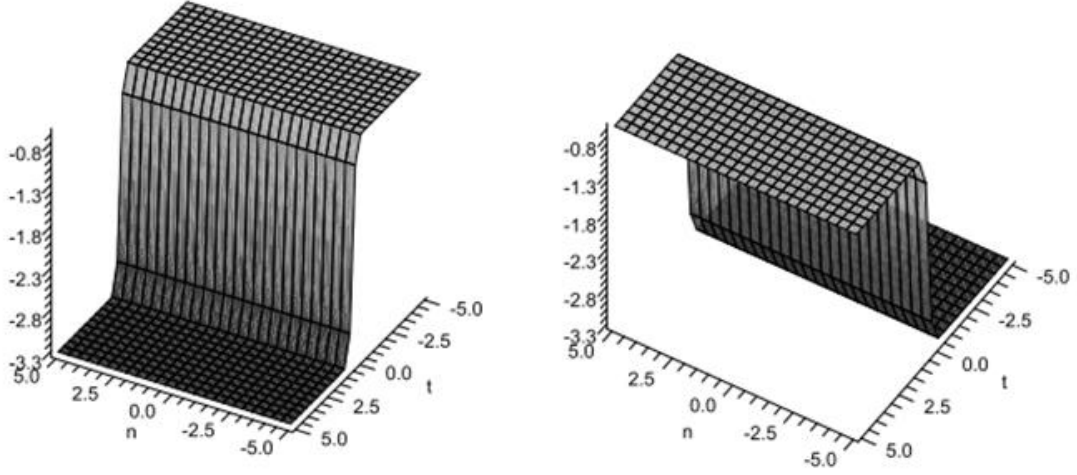

Figure 1.1 $u_n(t) = u^\pm(\zeta_n)$ in (1.26) and $\beta = 4, \alpha = 1, d = 1$ and $\zeta_0 = 0$

Case 2:

We put the solution in the following form

$$u(\zeta_n) = \sum_{i=0}^k A_i \tanh^i(\zeta_n) + \sum_{j=1}^k B_j \operatorname{sech}^j(\zeta_n) \tanh^{j-1}(\zeta_n) \quad (1.27)$$

Then by using the homogeneous balance principle is obtained $k = 1$, so the solution is written:

$$u(\zeta_n) = A_0 + A_1 \tanh(\zeta_n) + B_1 \operatorname{sech}(\zeta_n) \quad (1.28)$$

Where A_0 and A_1 and B_1 are constants to be determined later. Similarly, we can derive some algebraic equations by placing the coefficients of $\tanh^i(\zeta_n) \operatorname{sech}^j(\zeta_n)$ ($i = 0, 1, 2, 3; j = 0, 1$) zero. According to (1.28), travelling wave solutions of Eq. (1.16) are identified as bell-type solutions and kink-shaped solitary solutions:

$$u_n(t) = \frac{-\beta \pm \sqrt{4\alpha - \beta^2}}{2} \sinh(d) \operatorname{sech}(\zeta_n) \quad (1.29)$$

and

$$u_n(t) = \frac{-\beta \pm \sqrt{\beta^2 - 4\alpha}}{2} \tanh\left(\frac{d}{2}\right) \left(\tanh(\zeta_n) \pm i \operatorname{sech}(\zeta_n) \right) \quad (1.30)$$

where

$$\zeta_n = nd + \frac{4\alpha - \beta^2}{2} \sinh(d)t + \zeta_0 \quad \text{for Eq (1.29)}$$

and

$$\zeta_n = nd + \frac{4\alpha - \beta^2}{2} \tanh\left(\frac{d}{2}\right)t + \zeta_0 \quad \text{for Eq (1.30)}$$

Note that the hybrid-lattice systems in the literature [64, 65, 51, 66] are of the same type to the nonlinear lattice equation which it studied by tanh-method. It is found that some of their exact solutions are uniform with the exact solutions obtained by tanh-method if the parameters and coefficients are appropriately chosen. if we pay attention to the work of [65], in which Zhu successfully gave three kinds of exact travelling wave solutions by using exp-function method: namely, monotone decreasing solution, monotone increasing solution and symmetry solution with a jump wave. These three types of travelling wave solutions are also obtained by tanh-method. The difference between tanh-method and Zhu's could be the curvature of the curve for monotone wave solutions and the amplitude of the wave for symmetry solution with jump.

1.2.2.3 The method coth and coth-csch functions

We further extend those methods to construct more new types of exact solutions using the coth-function method. It will be shown that the proposed coth-function method can construct coth-form travelling wave solutions for non-linear lattice equations. Furthermore, through generalizing the coth-function we can obtain a general form of hyperbolic functions which can be used to construct exact travelling wave solutions for the non-linear lattice equations. The proposed coth-function method is verified by obtaining new types of exact solutions for some DDEs whose solutions had been successfully constructed by tanh-function method. The coth- and csch-form solutions can also be found from the proposed coth-

method under some special cases. The method can also deduce triangular type periodic wave solutions by using the similarity properties of triangular functions and hyperbolic functions.

1.2.2.4 The method coth function

We propose coth-function method to solve the equation (1.1) where it's written as following form:

$$u_n(t) = \sum_{i=0}^k A_i \coth^i(\zeta_n) =: u(\zeta_n) \quad (1.40)$$

Substituting (1.40) in (1.1), we can obtain an equivalent equation (1.1) as in Eq (1.4)

For reasons of convenience, we use $O\left(\frac{d^p u}{d\zeta_n^p}\right)$ to represent the highest order of a polynomial, there are

$$O\left(\frac{d^p u}{d\zeta_n^p}\right) = k + p, \quad p = 0, 1, 2, \dots$$

$$O\left(u^q \frac{d^p u}{d\zeta_n^p}\right) = (q + 1)k + p, \quad q, p = 0, 1, 2, \dots$$

This is the homogeneous balance principle.

We notice that $\frac{d^p u}{d\zeta_n^p}$ and $u^q \frac{d^p u}{d\zeta_n^p}$ are polynomials of $\coth(\zeta_n)$ and $\operatorname{csch}(\zeta_n)$, it was therefore

$$\zeta_{n+l_i} = (n + l_i)d + ct + \zeta_0 = \zeta_n + dl_i, \quad i = 1, 2, \dots, m,$$

$$\begin{aligned} \coth^2 x - \operatorname{csch}^2 x &= 1 \\ \operatorname{csch} x &= 1 / \sinh x \end{aligned} \quad (1.41)$$

The relation (1.4) present a system of algebraic equations for c, A_0, \dots, A_k , all coefficients of $\coth^i(\zeta_n)$ are zero. Therefore, solving the nonlinear algebraic system with the help of Mathematica, the final shape of the solution $u(\zeta_n)$ can be obtained.

1.2.2.5 The exact solutions of the wave of Eq. (1.16)

We now present the travelling wave solutions of eq. (1.21) by applying the method coth function. According to the homogeneous balance principle, we find $k = 1$ in Eq (1.21), we have

$$u(\zeta_n) = A_0 + A_1 \coth(\zeta_n) \quad (1.42)$$

where A_0 and A_1 are constants to be determined later, we also have the following interesting expressions

$$u(\zeta_n + 1) = A_0 + \frac{A_1(\coth(\zeta_n)\coth(d) + 1)}{\coth(\zeta_n) + \coth(d)} \quad (1.43)$$

$$u(\zeta_n - 1) = A_0 + \frac{A_1(\coth(\zeta_n)\coth(d) - 1)}{\coth(\zeta_n) - \coth(d)} \quad (1.44)$$

$$\coth'(\zeta_n) = 1 - \coth^2(\zeta_n) \quad (1.45)$$

we set $\omega(\zeta_n) = \coth(\zeta_n)$ therefore

$$\frac{d}{d\zeta_n} = \frac{d}{d\omega} \frac{d\omega}{d\zeta_n} = (1 - \omega^2) \frac{d}{d\omega} \quad (1.46)$$

we have

$$\frac{du(\zeta_n)}{d\zeta_n} = (1 - \omega^2) \frac{du(\zeta_n)}{d\omega} = (1 - \omega^2) A_1 \quad (1.47)$$

and

$$u'(\zeta_n) = A_1(1 - \coth^2(\zeta_n)) \quad (1.48)$$

Substituting (1.42), (1.43), (1.44) and (1.48) in Eq. (1.21) gives

$$\begin{aligned} & (2\alpha \coth(d) + 2\beta A_0 \coth(d) + 2A_0^2 \coth(d) - c \coth^2(d)) + \\ & (2\beta A_1 \coth(d) + 4A_1 \coth(d)) \coth(\zeta_n) + (2A_1^2 \coth(d) + c) \coth(\zeta_n) = 0 \end{aligned} \quad (1.49)$$

By setting the coefficients of $\coth^i(\zeta_n)$, ($i = 0, 1, 2$) to zero, we obtain a set of nonlinear algebraic equations for c , A_0 and A_1 :

$$\begin{aligned} 2\alpha \coth(d) + 2\beta A_0 \coth(d) + 2A_0^2 \coth(d) - c \coth^2(d) &= 0 \\ 2\beta A_1 \coth(d) + 4A_1 \coth(d) &= 0 \\ 2A_1^2 \coth(d) + c &= 0 \end{aligned} \quad (1.50)$$

We can get

$$\begin{aligned} A_0 &= -\frac{\beta}{2}, \\ c &= \frac{4\alpha - \beta^2}{2} \tanh(d), \\ A_1 &= \pm \frac{\sqrt{\beta^2 - 4\alpha}}{2} \tanh(d) \end{aligned}$$

Thus a pair of displacement solutions (1.42) is obtained

$$u_n(t) = u^\pm(\zeta_n) = -\frac{\beta}{2} \pm \frac{\sqrt{\beta^2 - 4\alpha}}{2} \tanh(d) \coth(\zeta_n) \quad (1.51)$$

We note that we obtain Kink-shaped soliton solutions, where $\zeta_n = nd + \frac{4\alpha - \beta^2}{2} \tanh(d)t + \zeta_0$ and d, ζ_0 are arbitrary constants provided by the user. Graphically, we illustrate the solutions Eq. (1.51) in the Figures (1.2, et 1.3), the physical wave $u_n[n, t] = u^+[\xi_n]$, and Figures (1.4 and 1.5), the physical wave $u_n[n, t] = u^-[\xi_n]$.

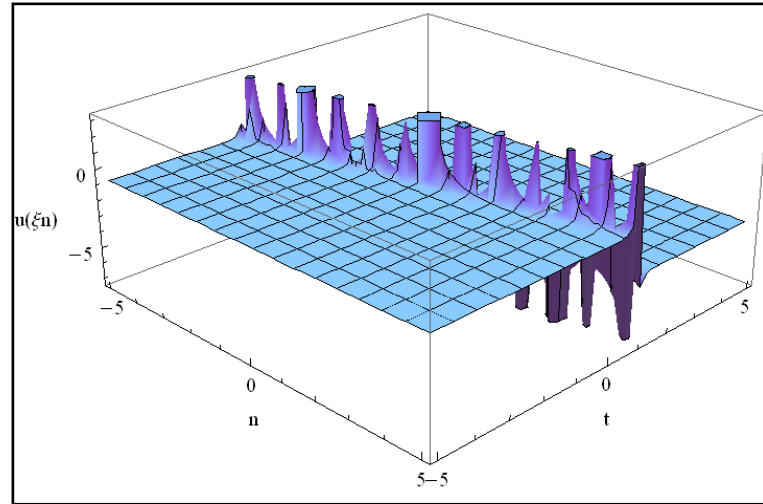

Figure 1.2 Plot 3D representation of $u_n[n, t] = u^+[\xi_n]$ and $\alpha = 1, \beta = 4, d = 1, \zeta_0 = 0$

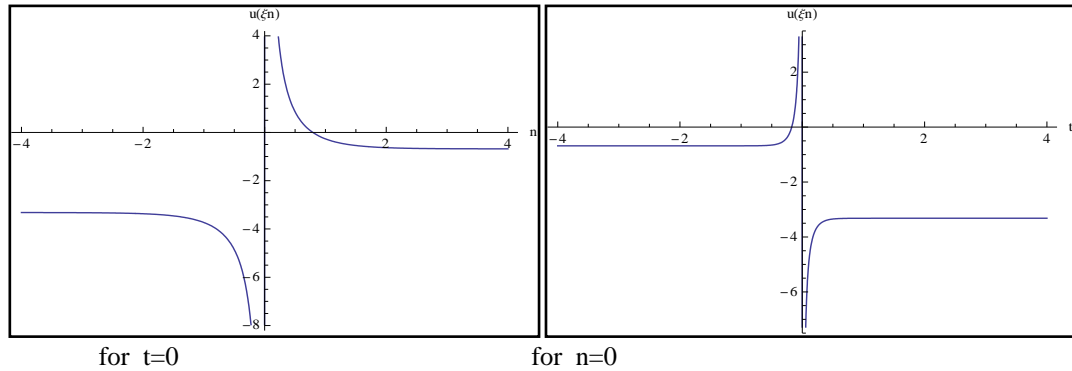

Figure 1.3 Plot 2D representation of $u_n[n, t] = u^+[\xi_n]$ and $\alpha = 1, \beta = 4, d = 1, \zeta_0 = 0$

1.2.2.6 Method coth-csch

It can be shown that the proposed coth-csch function method can construct coth-csch form travelling wave solutions for equations (1.21) under form

$$u(\zeta_n) = A_0 + \sum_{j=1}^k A_j \coth^j(\zeta_n) + B_j \operatorname{csch}^j(\zeta_n) \coth^{j-1}(\zeta_n) \quad (1.52)$$

Substituting (1.52) into (1.1), we can obtain an equivalent equation (1.1) as in Eq. (1.4). So by the homogeneous balance principle, we obtain $k = 1$

$$u(\zeta_n) = A_0 + A_1 \coth(\zeta_n) + B_1 \operatorname{csch}(\zeta_n) \quad (1.53)$$

Where A_0, A_1 and B_1 are constants to be determined later. We write the following practical expression

$$\begin{cases} u(\zeta_n + 1) = A_0 + \frac{A_1(\coth(\zeta_n)\coth(d) + 1)}{\coth(\zeta_n) + \coth(d)} + B_1 \frac{\operatorname{csch}(d)\operatorname{csch}(\zeta_n)}{\coth(d) + \coth(\zeta_n)} \\ u(\zeta_n - 1) = A_0 + \frac{A_1(\coth(\zeta_n)\coth(d) - 1)}{\coth(\zeta_n) - \coth(d)} + B_1 \frac{\operatorname{csch}(d)\operatorname{csch}(\zeta_n)}{\coth(d) - \coth(\zeta_n)} \end{cases} \quad (1.54)$$

and

$$u'(\zeta_n) = -A_1 \operatorname{csch}^2(\zeta_n) - B_1 \coth(\zeta_n) \operatorname{csch}(\zeta_n) \quad (1.55)$$

Similarly, we can derive a system of algebraic equations by substitution of (1.53), (1.54) and (1.55) in Eq. (1.21) and placing the coefficients of $\coth^i(\zeta_n) \operatorname{csch}^j(\zeta_n), (i = 0, 1, 2, 3, j = 0, 1)$ to zero, we obtain the traveling wave solution Eq. (1.21) is then the system

$$\left\{ \begin{array}{l}
cA_1 + 2A_1B_1^3 \operatorname{csch}(d) + (A_1^2 + B_1^2)2A_1 \coth(d) = 0 \\
cA_1 + 2A_1B_1^3 \operatorname{csch}(d) + (A_1^2 + B_1^2)2A_1 \coth(d) = 0 \\
cB_1 \coth(d)^2 + 4A_1^2B_1 \coth(d) - (\alpha + \beta A_0 + A_0^2 - B_1^2)2B_1 \operatorname{csch}(d) = 0 \\
cB_1 - (A_1^2 + B_1^2)2B_1 \operatorname{csch}(d) - 4A_1^2B_1 \coth(d) = 0 \\
(2A_0B_1 + \beta B_1)2A_1 = 0 \\
(2A_0A_1 + \beta A_1)2A_1 \coth(d) + (2A_0B_1 + \beta B_1)2B_1 \operatorname{csch}(d) = 0 \\
-cA_1 \coth(d) + (\alpha + \beta A_0 + A_0^2 - B_1^2)2A_1 = 0
\end{array} \right. \quad (1.56)$$

Who provides symmetrically bell solutions and symmetrically kink-shaped soliton solutions and symmetrically kink-shaped solitary solution as

$$u_n(t) = u^\pm(\zeta_n) = -\frac{\beta}{2} \pm \frac{\sqrt{-4\alpha + \beta^2}}{2} \sinh(d) \operatorname{csch}(\zeta_n) \quad (1.57)$$

and

$$u_n(t) = u^\pm(\zeta_n) = -\frac{\beta}{2} \pm \frac{\sqrt{\beta^2 - 4\alpha}}{2} \tanh\left(\frac{d}{2}\right) (\coth(\zeta_n) \pm \operatorname{csch}(\zeta_n)) \quad (1.58)$$

and

$$u_n(t) = u^\pm(\zeta_n) = -\frac{\beta}{2} \pm \frac{\sqrt{\beta^2 - 4\alpha}}{2} \tanh(d) \coth(\zeta_n) \quad (1.59)$$

where $\zeta_n = nd + \frac{4\alpha - \beta^2}{2} \sinh(d)t + \zeta_0$ in (1.57)

and $\zeta_n = nd + \frac{4\alpha - \beta^2}{2} \tanh\left(\frac{d}{2}\right)t + \zeta_0$ in (1.58)

and $\zeta_n = nd + \frac{4\alpha - \beta^2}{2} \tanh(d)t + \zeta_0$ in (1.59)

The configuration of (1.57) is shown in Fig. 1.3

1.3 Discussion and conclusion

In this chapter, we have proposed methods to construct various kinds of exact travelling wave solutions for nonlinear differential–difference equations (NDDEs); which include several famous lattice equations such as non–linear equation.

The efficiency of the homogeneous balance method (HBM) can be demonstrated on a large variety for a class of nonlinear evolution equations to obtain many kinds of exact travelling wave solutions. Those solutions may be useful for describing certain nonlinear phenomena. Thus, the extended homogeneous balance method is more effective and simple than the other methods where a lot of solutions can be obtained in the same time.

The computation procedure of HBM and several other methods show that computer algebra such as Mathematica plays an important role in solving the NDDEs, accurately, which include generalized soliton solutions, kink–type solitary solutions and travelling wave solutions. Therefore, we think that expanded method is a new powerful method for four symmetrical solutions of NDDEs. Through its application, closed form solutions and periodic solutions of a lattice equation are obtained.

Various discussions and calculations on different examples have indicated to the validity of generalized tanh–function method, that can be also extended to many NDDEs. On the one hand, generalized tanh–function method can be used in the study of a nonlinear lattice equation, and the result is six types of new exact traveling wave solutions that are obtained. On the other hand, in our work, we have provided a new trial travelling solution to find the exact structures of solutions to the nonlinear lattice equation. Two types of functions are used to find the exact solutions; namely: the coth–function and the coth–csch function methods and the result is eight variants of new exact travelling wave solutions that are obtained. Hence, the present method provides a reliable technique that requires less work if compared with the difficulties arising from computational aspect. This method has been successfully applied for solving some nonlinear wave equations. For example a wide variety of modern examples of applications from nonlinear areas of plasma physics, fluid dynamics, nonlinear optics and gas dynamics can be carefully handled by this method.

In summary, we may conclude that, this method is a reliable and straightforward to find wave solutions of closed structure, for travelling waves of nonlinear partial differential equations (NPDEs). It will be then interesting to study more general systems, this point will be considered in the following chapter.

References

- [1] Ablowitz MJ, Clarkson PA. Solitons, nonlinear evolution equations and inverse scattering transform. Cambridge: Cambridge University Press, 1990.
- [2] Vakhnenko VO, Parkes EJ, Morrison AJ. A Bäcklund transformation and the inverse scattering transform method for the generalised Vakhnenko equation. *Chaos Soliton Fract* , 2003, vol 17(4), 683.
- [3] Hirota R. Direct method of finding exact solutions of nonlinear evolution equations. In: Bullough R, Caudrey P, editors. Backlund a transformations. Berlin: Springer;, 1980, 1157.
- [4] Malfliet W, Hereman W. The tanh method. I: Exact solutions of nonlinear evolution and wave equations. *Physica Scripta*, 1996, vol 54, 563.
- [5] Wazwaz AM. The tanh method for travelling wave solutions of nonlinear equations. *Appl Math Comput*, 2004, vol 154(3), 713.
- [6] Yusufog̃lu E, Bekir A. Exact solutions of coupled nonlinear evolution equations. *Chaos Soliton Fract* , 2008, vol 37(3) , 842.
- [7] El-Wakil SA, Abdou MA. New exact travelling wave solutions using modified extended tanh-function method. *Chaos Soliton Fract*, 2007, vol 31(4), 840.
- [8] Fan E. Extended tanh-function method and its applications to nonlinear equations. *Phys Lett A*, 2000, vol 277, 212.
- [9] Wazwaz AM. The extended tanh method for abundant solitary wave solutions of nonlinear wave equations. *Appl Math Comput* , 2007, vol 187, 1131.

- [10] Wazwaz AM. A sine–cosine method for handling nonlinear wave equations. *Math Comput Model* , 2004, vol 40, 499.
- [11] Bekir A. New solitons and periodic wave solutions for some nonlinear physical models by using sine–cosine method. *Physica Scripta* , 2008, vol 77(4), 501.
- [12] Fan E, Zhang H. A note on the homogeneous balance method. *Phys Lett A* , 1998, vol 246, 403.
- [13] M.L. Wang, Solitary wave solutions for variant Boussinesq equations, *Physics Letters A* , 1995, vol 199 , 169.
- [14] M.L. Wang, Exact solutions for a compound KdV-Burgers equation, *Physics Letters A* , 1996, vol 213 , 279.
- [15] E.G. Fan, H.Q. Zhang, New exact solutions to a system of coupled KdV equations , *Physics Letters A* , 1998, vol 245 , 389.
- [16] E.G. Fan, H.Q. Zhang, A note on the homogeneous balance method, *Physics Letters A* , 1998, vol 246 , 403.
- [17] E. Fermi, J. Pasta, S. Ulam, *Collected Papers of Enrico Fermi*, University of Chicago Press, Chicago, 1965, 978.
- [18] M.S. Hickman, W.A. Hereman, computation of densities and fluxes of nonlinear differential-difference equations, *Proc. Roy. Soc. Lond.Ser A* , 2003, vol 459 , 2705–2729.
- [19] G.Suty Monogr, Teschl, *Jacobi Operators and Completely Integrable Nonlinear Lattices*, Amer Math. Soc., Providence,RI, 2000, vol 72.
- [20] W. Hereman, J.A. Sanders, J. Sayers, J.P.Wang, in: D. Levi, P.Winternitz (Eds.), *Symbolic computation of conserved densities, generalized symmetries, and recursion*

- operators for nonlinear differential–difference equations, in: CRM Proc. and Lect. Notes,, Amer. Math. Soc., Providence, RI, 2004, vol 39, 7.
- [21] D. Levi, O. Ragnisco, Application of Rational Expansion Method for Differential-Difference Equation, *Lett. Nuovo Cimento* , 1978, vol 22, 691–696.
- [22] D. Levi, R.I. Yamilov, Conditions for the existence of higher symmetries of evolutionary equations on the lattice, *Journal of Mathematical Physics*, 1997, vol 38, 6648–6674.
- [23] R.I. Yamilov, Classification of Toda type scalar lattices, in: V. Makhankov, I. Puzynin, O. Pashaev (Eds.), *Proc. 8th Internat. Workshop on Nonlinear Evolution Equations and Dynamical Systems*, World Scientific, Singapore, 1993, 423–431.
- [24] R.I. Yamilov, Construction scheme for discrete Miura transformations, *J. Phys. A: Math. Gen*, 1994, vol 27, 6839–6851.
- [25] V.E. Adler, S.I. Svinolupov, R.I. Yamilov, Multi-component Volterra and Toda type integrable equations, *Physics Letters. A* , 1999, vol 254, 24–36.
- [26] I.Yu. Cherdantsev, R.I. Yamilov, Master symmetries for differential-difference equations of the Volterra type, *Physica D* , 1995, vol 87, 140–144.
- [27] I.Yu. Cherdantsev, R. Yamilov, Local master symmetries of differential–difference equations, in: D. Levi, L. Vinet, P. Winternitz (Eds.), *Symmetries and Integrability of Difference Equations*, in: CRM Proc. and Lect. Notes, vol. 9, Amer. Math. Soc., Providence, RI, 1996, 51–61.
- [28] A.B. Shabat, R.I. Yamilov, Symmetries of nonlinear chains, *Leningrad Math. J*, 1991 , vol 2 (2) , 377–400.

- [29] A.B. Shabat, R.I. Yamilov, , To a transformation theory of two-dimensional integrable systems, *Phys. Lett. A* , 1997, vol 227, 15–23.
- [30] S.I. Svinolupov, R.I. Yamilov, The multi-field Schrodinger lattices, *Phys. Lett. A*, 1991, vol 160, 548–552.
- [31] Yu.B. Suris, New integrable systems related to the relativistic Toda lattice, *J. Phys. A*, 1997, vol 30 , 1745–1761.
- [32] Yu.B. Suris, On some integrable systems related to the Toda lattice, *J. Phys. A*, 1995, vol 30 , 2235–2249.
- [33] Yu.B. Suris, Miura transformations for Toda-type integrable systems, with applications to the problem of integrable discretizations, Preprint, Fachbereich Mathematik, Technische Universität Berlin, Berlin, Germany, 1998, vol 367, 288.
- [34] Yu.B. Suris, Integrable discretizations for lattice systems: local equations of motion and their Hamiltonian properties, *Rev. Math. Phys*, 1999, vol 11, 727–822 .
- [35] Yu.B. Suris, A reply to a comment: a note on an integrable discretization of the nonlinear Schrödinger equation, *Inverse Problems*, 2000, vol 16 , 1071–1077.
- [36] Yu.B. Suris, The Problem of Integrable Discretization: Hamiltonian Approach, *Progress in Mathematics*, 2003, vol. 219, 1070.
- [37] Von M. Toda, *Theory of Nonlinear Lattices*, Springer-Verlag, Berlin, 1981.
- [38] S.N.M. Ruijsenaars, Relativistic Toda systems, *Comm. Math. Phys*, 1990 , vol 133 , 217–247.
- [39] D. Baldwin, Ü. Göktaş, W. Hereman, L. Hong, R.S. Martino, J.C. Miller, PDE Special Solutions.m: A Mathematica program for the symbolic computation of exact

- solutions expressible in hyperbolic and elliptic functions for nonlinear PDEs,
http://www.mines.edu/fs_home/whereman/, 2001.
- [40] Z.B. Li, Y.P. Liu, Rath: A maple package for finding traveling solitary wave solutions to nonlinear evolution equations, , *Comput. Phys. Commun*, 2002, vol148 , 256–266.
- [41] Y.P. Liu, Z.B.Li, A maple package for exact solitary wave solutions of coupled nonlinear evolutions, *Phys. Commun*, 203, vol 155, 65-76.
- [42] G.Adomian. *Solving frontier problems of physics: The decomposition method*. Kluwer, 1994.
- [43] G.Adomian. *Nonlinear stochastic operator equations*. Academic Press, 1996.
- [44] N.Freeman, R.Johnson. Shallow water waves on shear flows. *Journal of Fluid Mechanics*, 1970, vol 42, 401–409.
- [45] D.Korteweg, G.Vries. On the change of the form of long waves advancing in a rectangular canal and on a new type of long stationary waves. *Philosophical Magazine*, 1895, vol 39, 422–443
- [46] Sirendaoreji .New exact travelling wave solutions for the Kawahara and modified Kawahara equations. *Chaos, Solitons and Fractals*, 2004, vol 19, 147–150.
- [47] Sirendaoreji. Auxiliary equation method and new solutions of Klein Gordon equations. *Chaos, Solitons and Fractals*, 2007, vol 31, 943–950..
- [48] D. Wang, H. Li. Symbolic computation and non-travelling wave solutions of (2+1)-dimensional nonlinear evolution equations. *Chaos Solitons and Fractals*, 2008, vol 38, 383–390.

- [49] A.Zerarka. Solution of korteweg-de vries equation by decomposition method .in: International Congress on industrial and Applied Mathematics, Sc, Casa,1996.
- [50] Boyce, William E.; Di Prima, Richard C, Elementary Differential Equations and Boundary Value Problems, John Wiley and Sons, 1967, vol 3
- [51] ZHANG Shan-qing, A New Expanded Method for Solving Nonlinear Differential-difference Equation, J. Shanghai Jiaotong Univ. (Sci.), 2008, vol 13(4), 509–512.
- [52] Wadati M. Transformation Theories for Nonlinear Discrete Systems [J]. Progress of Theoretical Physics Supplement, 1976, vol 59, 36–63.
- [53] Baldwin D, Goktas U, Hereman W. Symbolic computation of hyperbolic tangent solutions for nonlinear differential-difference equations [J]. Computer Physics Communications, 2004, vol 162(3), 203–217.
- [54] Xie F D, Wang J Q. A new method for solving nonlinear differential-difference equation [J]. Chaos, Soltions and Fractals, 2006, vol 27(4): 1067–1071.
- [55] Chufen Wu and PeixuanWeng. New Exact Solutions for a Nonlinear Lattice Equation- Southeast Asian Bulletin of Mathematics , 2009, vol 33, 587-596
- [56] M. L. Wang, Solitary wave solutions for variant boussinesq equations, Phys. Lett. A , 1995, 199 , 169-172.
- [57] J. H. He, Non-Perturbative Methods for Strongly Nonlinear Problems, dissertation. De-Verlagim Internet GmbH, Berlin, 2006.
- [58] J. H. He, X. H. Wu, Exp-function method for nonlinear wave equations, Chaos, Soliton and Fractals, 2006, vol 30 , 700-708.
- [59] J. H. He, M. A. Abdou, New periodic solutions for nonlinear evolution equations using exp-function method, Chaos, Soliton and Fractals, 2007, vol 34, 1421-1429.

- [60] W. Malfliet, Solitary wave solutions of nonlinear wave equations, *Am.J.Phys* , 1992, vol 60, 650-654.
- [61] E.G. Fan, Extended tanh-function method and its applications to nonlinear equations, *Phys. Lett. A*, 2000, vol 277, 212-218.
- [62] Z. B. Li, Y. P. Liu, Rath: A maple package for finding traveling solitary wave solutions to nonlinear evolution equations, *Comput. Phys. Commun*, 2002, vol 148, 256-266.
- [63] Z. B. Li, Y. P. Liu, A maple package for finding exact solitary wave solutions of coupled nonlinear evolutions, *Comput. Phys. Commun*, 2003, vol 155, 65-76
- [64] Z.H. Yang, Y. C. Hon, A generalized coth-function method for exact solution of Differential -difference equations, *Chaos, Soliton and Fractals*, 2007, vol 33 , 1694-1702.
- [65] Y. X. Yu, Rational formal solutions of hybrid lattice equation, *Appl. Math. and Comput*, 2007, vol 186 , 474-482.
- [66] S.D. Zhu, Exp-function method for the hybrid-lattice systems, *Int. J. Nonlinear Sci. Numer. Simul*, 2007, vol 8 , 461-464.
- [67] S.D. Zhu, Exp-function method for the discrete mKdV lattice, *Int. J. Nonlinear Sci. Numer. Simul*, 2007, vol 8 , 465-468.
- [68] S.D. Zhu, Discrete (2+1)-dimensional Toda lattice equation via exp-function method, *Phys. Lett. A* , 2008, vol 372 (5) , 654-657.
- [69] J. B. Liu and K. Q. Yang. The Extended F-expansion Method and Exact Solutions of Nonlinear PDEs. *Chaos, Solitons and Fractals*, 2004, vol 22, 111-121.
- [70] He JH. Some asymptotic methods for strongly nonlinear equations. *Int J Mod Phys B* , 2006, vol 20(10), 1141-99.

Chapter 2

Exact fractional solutions of nonlinear lattice equation via some fractional transformation methods

2.1 Introduction

The effort to find an exact solution of nonlinear equation by using powerful methods is important to understand most non-linear physical phenomena. So, in this chapter we will introduce strange and effective method, where we will extend the fractional transformations method that it can be used to deal with a class of nonlinear equations and to investigate many types of new fractional solutions of nonlinear equations.

Similarly, the corresponding of a fractional transformations method has found that the solutions are necessarily of rational form, containing both trigonometric and hyperbolic types and terms quadratic in Jacobi elliptic functions [1], in addition to having constant terms, this method used to connect the travelling wave solutions of the nonlinear Schrödinger equation (NLSE), phase locked with a source, to the elliptic equations satisfying[2], which currently is an area of active research such as the seminal work of Kaup and Newell [3], the Miura transformation [4]. Among the several applications of an externally driven NLSE, perhaps the most important ones are Josephson junctions [5], charge density waves [6], plasmas driven by rf fields [7] and chaotic phenomena [8]. The phenomenon of auto-resonance [9, 10], the solitary wave solutions of the NLSE [11-14].Also, the fractional transformations method studied exact solutions in obtaining the GNLS equation [15] by using some transformations [16-21].

To more understand in solving non-linear problems, we first consider given NPDEs system [22].for the lattice equation with some physicals fields $u(t, x, y, z, \dots)$ as

$$P(u, u_x, u_y, u_z, u_{xy}, u_{yz}, u_{xz}, u_{xx}, \dots) = 0 \quad (2.1)$$

where the subscript denotes partial derivative, P is some function, $u(t, x, y, z, \dots)$ and is called a dependent variable or unknown function to be determined.

By using the wave transformation

$$\zeta = \sum_{i=0}^p \alpha_i \chi_i + \zeta_0, \quad (2.2)$$

χ_i are the independent variables, and δ and α_i are free parameters. When

$p=1$, $\zeta = \alpha_0 \chi_0 + \alpha_1 \chi_1 + \zeta_0$, the parameters α_0, α_1 are identified as the wave pulsation ω and the wave number k respectively if χ_0, χ_1 are the variables t and x respectively. In the discrete case for the position x and with continues variable for the Time t , ζ becomes $\xi_n = nd + ct + \zeta_0$ and n is the discrete variable, d and ζ_0 are arbitrary constants.

We introduce the following transformation for a travelling wave solution of Eq. (1),

$$u(\chi_0, \chi_1, \dots) = u(\zeta) \quad (2.3)$$

and the chain rule

$$\frac{\partial}{\partial \chi_i} (\cdot) = \alpha_i \frac{d}{d\xi} (\cdot), \frac{\partial^2}{\partial \chi_i \partial \chi_j} (\cdot) = \alpha_i \alpha_j \frac{d^2}{d\xi^2} (\cdot), \dots \quad (2.4)$$

By using (2.3) and (2.4), the nonlinear partial differential equation (2.1) is reduced to a nonlinear ordinary differential equation (ODE)

$$Q(U, U_\xi, U_{\xi\xi}, U_{\xi\xi\xi}, U_{\xi\xi\xi\xi}, \dots) = 0 \quad (2.5)$$

2.2 Applications

In our applications of fractional transformations methods, we will focus on the extraction travelling wave solutions from The one-dimensional Lattice system (1.16) which it reads

$$\frac{du_n(t)}{dt} - (\alpha + \beta u_n(t) + u_n^2(t))(u_{n+1}(t) - u_{n-1}(t)) = 0 \quad (2.6)$$

Where
$$u_n(t) = u(n, t)$$

We first combine the independent variables, into a wave variable using ζ_n as

$$\zeta_n = nd + ct + \zeta_0 \quad (2.7)$$

We seek the travelling wave solutions of the system (2.6) using (2.7) as $u(n, t) = u(\zeta_n)$ and upon using eq (2.4), the system (2.6) leads to the transformed system which is

$$cu'(\zeta_n) - (\alpha + \beta u(\zeta_n) + u^2(\zeta_n))(u(\zeta_{n+1}) - u(\zeta_{n-1})) = 0 \quad (2.8)$$

where α and β are constants and $u(\zeta_n)$ is a travelling wave function which represents the solution of equation (2.8). The travelling wave solutions for a big class of nonlinear equations can be expressed as fractional transformations.

2.3 The fractional transformation methods

For facilitating and simplify the fractional transformations method has found that the solutions are necessarily of rational form. We assume the travelling wave type solutions for solving the non-linear lattice equation written as follows

$$u(\zeta_n) = \frac{a + b\varphi^2(\zeta_n)}{j + \varphi^2(\zeta_n)} \quad (2.9)$$

where a and b and j are constants to be determined later and $\varphi(\zeta_n)$ is a function of ζ_n . We now present five cases of exact travelling wave solutions of Eq. (2.8)

Case 1: $\varphi(\zeta_n) = \zeta_n$

Eq. (2.9) becomes

$$u(\zeta_n) = \frac{a + b(\zeta_n)^2}{j + (\zeta_n)^2} \quad (2.10)$$

We write the following practical expression

$$\begin{cases} \zeta_{n+1} = \zeta_n + d \\ \zeta_{n-1} = \zeta_n - d \end{cases} \quad (2.11)$$

Then

$$u'(\zeta_n) = \frac{2(-a + bj)\zeta_n}{(j + \zeta_n^2)^2} \quad (2.12)$$

Substitution of (2.10), (2.11) and (2.12) in Eq. (2.8), and taking into account that the coefficients of $(\zeta_n)^i, (i = 0, 1, 2, \dots)$ are zero, it follows a set of nonlinear algebraic equations for c, a and b

$$\begin{cases} 2a^2d - cd^4 - 2cd^2j - cj^2 + 2dj^2\alpha + 2adj\beta = 0 \\ 4abd + 2cd^2 - 2cj + 4dj\alpha + 2ad\beta + 2bdj\beta = 0 \\ -c + 2b^2d + 2d\alpha + 2bd\beta = 0 \end{cases} \quad (2.13)$$

Solving the nonlinear algebraic system with the help of Mathematica we can obtain the unknown coefficients

$$\begin{aligned} a &= \left[\frac{-\beta J}{2} \pm (3j + d^2) \frac{d}{4} \sqrt{\frac{(4\alpha - \beta^2)}{j}} \right], \\ b &= \left[\frac{-\beta}{2} \pm \frac{d}{4} \sqrt{\frac{(4\alpha - \beta^2)}{j}} \right], \\ c &= \frac{d(d^2 + 4j)(4\alpha - \beta^2)}{8j} \end{aligned} \quad (2.14)$$

and the two rational travelling wave solutions of the problem of interest as follows as :

$$u^\pm(\zeta_n) = \frac{\left(\left(\frac{-\beta}{2} \pm \sqrt{\frac{d^2}{16j}(4\alpha - \beta^2)} \right) (3j + d^2 + \zeta_n^2) \right) + \left(\beta j + \frac{\beta d^2}{2} \right)}{j + \zeta_n^2} \quad (2.15)$$

where $\zeta_n = nd + \frac{d(d^2 + 4j)(4\alpha - \beta^2)}{8j}t + \zeta_0$, d and ζ_0 are arbitrary

constants. Graphically we illustrate the solutions Eq. (2.15) in the Figure (2.1), the physical wave $u_n[n, t] = u^+[\xi_n]$, and Figure (2.2), the physical wave $u_n[n, t] = u^-[\xi_n]$.

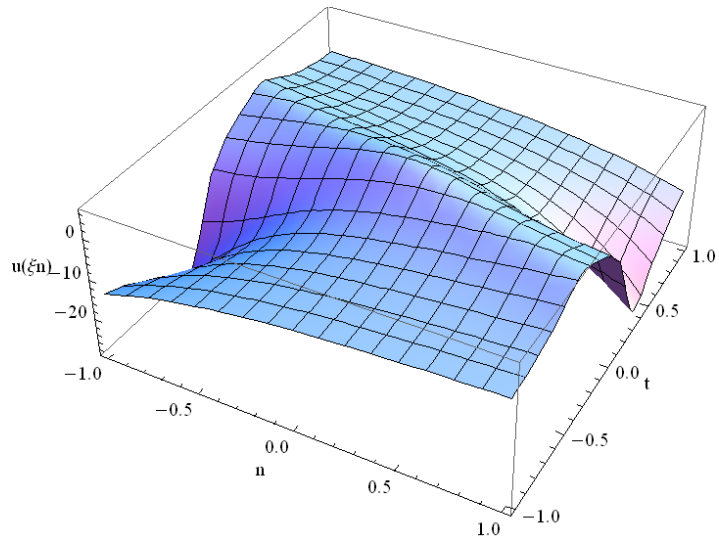

Figure 2.1 Plot 3D representation of $u_n[n, t] = u^+[\xi_n]$ and $\alpha=1, \beta=4, d=1$ and $\zeta_0 = 0, j = -0.5$

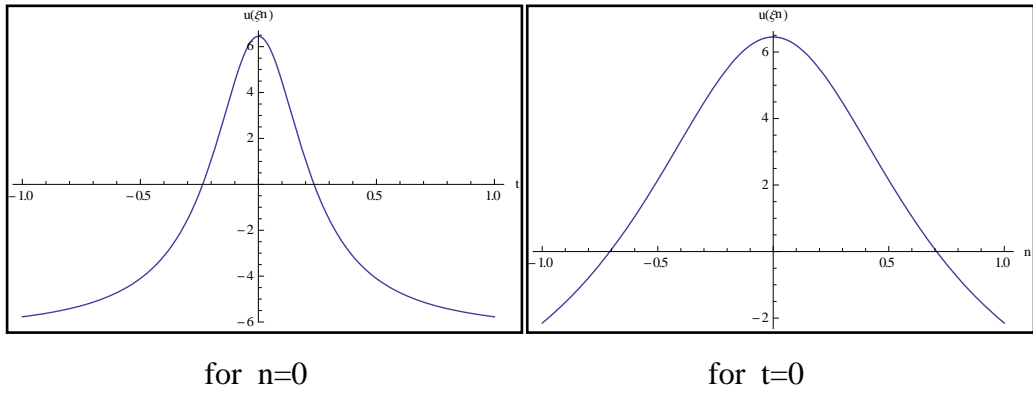

Figure 2.2 Plot 2D representation of $u_n[n, t] = u^+[\xi_n]$ and $\alpha=1, \beta=4, d=1$ and $\zeta_0 = 0, j = -0.5$

Case 2 : if $\varphi(\zeta_n) = \sin(\zeta_n)$ so that Eq. (2.9) becomes

$$u(\zeta_n) = \frac{a + b \sin^2(\zeta_n)}{j + \sin^2(\zeta_n)} \quad (2.16)$$

We have the following practical expression:

$$\sin(\zeta_n \pm d) = \sin(\zeta_n)\cos(d) \pm \cos(\zeta_n)\sin(d) \quad (2.17)$$

So that

$$\begin{cases} u(\zeta_{n+1}) = \frac{a + b(\sin(\zeta_n)\cos(d) + \cos(\zeta_n)\sin(d))^2}{j + (\sin(\zeta_n)\cos(d) + \cos(\zeta_n)\sin(d))^2} \\ u(\zeta_{n-1}) = \frac{a + b(\sin(\zeta_n)\cos(d) - \cos(\zeta_n)\sin(d))^2}{j + (\sin(\zeta_n)\cos(d) - \cos(\zeta_n)\sin(d))^2} \end{cases} \quad (2.18)$$

Where

$$u'(\zeta_n) = \frac{2(-a + bj)\cos(\zeta_n)\sin(\zeta_n)}{(j + \sin^2(\zeta_n))^2} \quad (2.19)$$

Substitution of (2.16), (2.18), (2.19) in Eq. (2.8), and taking into account that the coefficients of $\sin^i(\zeta_n)$, ($i = 0, 1, 2, \dots$) are zero, it follows a set of nonlinear algebraic equations for c , a , b and j :

$$\begin{cases} -cj^2 + (2a^2 + 2j^2\alpha + 2aj\beta)\cos(d)\sin(d) \\ -2cj\sin^2(d) - c\sin^4(d) = 0, \\ -2cj + (4ab + 4j\alpha + 2a\beta + 2bj\beta)\cos(d)\sin(d) \\ +4cj\sin^2(d) + 2c\sin^2(d) = 0, \\ -c + (2b^2 + 2\alpha + 2b\beta)\cos(d)\sin(d) = 0, \end{cases} \quad (2.20)$$

After some algebra, and with the help of Mathematica, the following values for the parameters are obtained

$$\begin{aligned}
a &= \frac{1}{2} \left(\frac{\beta}{2} \pm \sqrt{(-4\alpha + \beta^2)(\sin^2(d) - \sin^4(d))} \right), \\
b &= -\frac{\beta}{2}, \\
j &= -\frac{1}{2}, \\
c &= \frac{1}{2} (4\alpha - \beta^2) \cos(d) \sin(d),
\end{aligned} \tag{2.21}$$

This provides the periodic wave solutions

$$u^\pm(\zeta_n) = \frac{\frac{\beta}{2} \pm \sqrt{(-4\alpha + \beta^2)(\sin^2(d) - \sin^4(d))} - \beta \sin^2(\zeta_n)}{-1 + 2 \sin^2(\zeta_n)} \tag{2.22}$$

where $\zeta_n = nd + 0.5(4\alpha - \beta^2) \cos(d) \sin(d)t + \zeta_0$

we illustrate the solutions Eq. (2.22) in the Figure (2.3), the physical wave $u_n[n, t] = u^+[\xi_n]$, and Figure (2.4), the physical wave $u_n[n, t] = u^-[\xi_n]$.

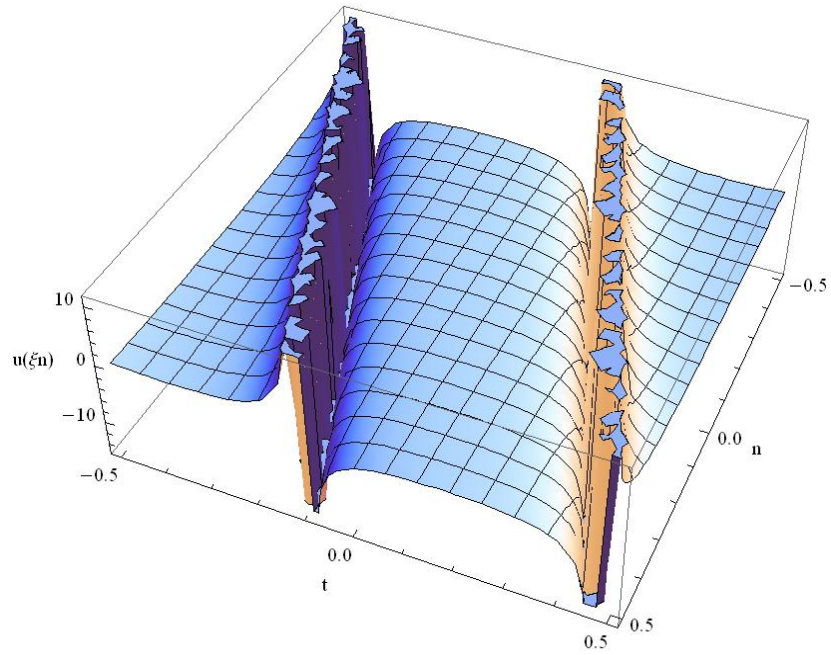

Figure 2.3 Plot 3D representation of $u_n[n, t] = u^+[\xi_n]$ and $\alpha=1, \beta=4, d=1$ and $\zeta_0 = 0$

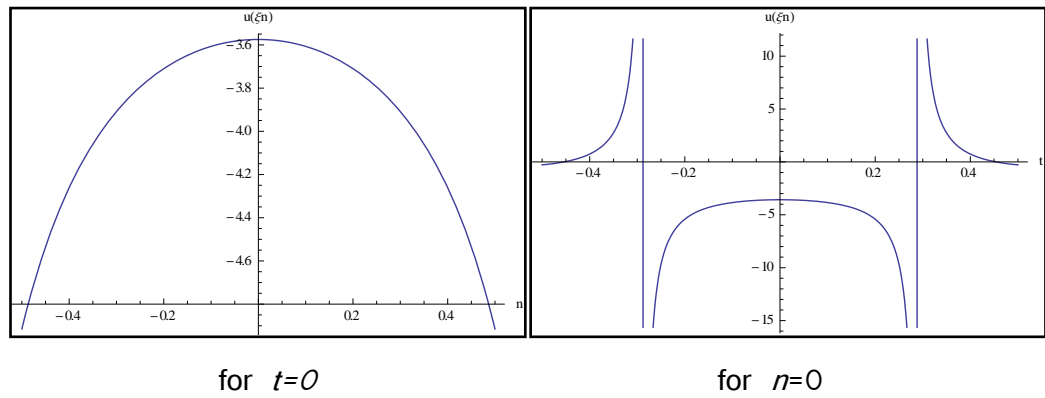

Figure 2.4 Plot 2D representation of $u_n[n, t] = u^+[\xi_n]$ and $\alpha=1, \beta=4, d=1$ and $\zeta_0 = 0$.

Case 3: if $\varphi(\zeta_n) = \sinh(\zeta_n)$, Eq. (2.9) becomes

$$u(\zeta_n) = \frac{a + b \sinh^2(\zeta_n)}{j + \sinh^2(\zeta_n)} \quad (2.23)$$

We write the following practical expression

$$\sinh(\zeta_n \pm d) = \sinh(\zeta_n) \cosh(d) \pm \cosh(\zeta_n) \sinh(d) \quad (2.24)$$

and therefore we have

$$\begin{cases} u(\zeta_{n+1}) = \frac{a + b(\sinh(\zeta_n) \cosh(d) + \cosh(\zeta_n) \sinh(d))^2}{j + (\sinh(\zeta_n) \cosh(d) + \cosh(\zeta_n) \sinh(d))^2} \\ u(\zeta_{n-1}) = \frac{a + b(\sinh(\zeta_n) \cosh(d) - \cosh(\zeta_n) \sinh(d))^2}{j + (\sinh(\zeta_n) \cosh(d) - \cosh(\zeta_n) \sinh(d))^2} \end{cases} \quad (2.25)$$

and

$$u'(\zeta_n) = \frac{2(-a + bj) \cosh(\zeta_n) \sinh(\zeta_n)}{(j + \cosh^2(\zeta_n))^2} \quad (2.26)$$

Substitution of (2.23), (2.25), (2.26) in Eq. (2.8), and with the help of Mathematica we get a system of algebraic equations with respect to a , b , j and c

$$\begin{cases} -cj^2 + (2a^2 + 2j^2\alpha + 2aj\beta) \cosh(d) \sinh(d) \\ -2cj \sinh^2(d) - c \sinh^4(d) = 0, \\ -2cj + (4ab + 4j\alpha + 2a\beta + 2bj\beta) \cosh(d) \sinh(d) \\ -4cj \sinh^2(d) + 2c \sinh^2(d) = 0, \\ -c + (2b^2 + 2\alpha + 2b\beta) \cosh(d) \sinh(d) = 0, \end{cases} \quad (2.27)$$

So that the final shape can be obtained from the solitary wave solutions:

$$u^\pm(\zeta_n) = \frac{\frac{\beta}{2} \pm \sqrt{(-4\alpha + \beta^2)(\sinh^2(d) - \sinh^4(d)) - \beta \sinh^2(\zeta_n)}}{-1 + 2\sinh^2(\zeta_n)} \quad (2.28)$$

Where

$$\zeta_n = nd + 0.5(4\alpha - \beta^2) \cosh(d) \sinh(d)t + \zeta_0$$

The configurations of solutions Eq. (2.28) are shown in the Figure (2.5), and Figure (2.6) for the physical wave $u_n[n, t] = u^-[\zeta_n]$.

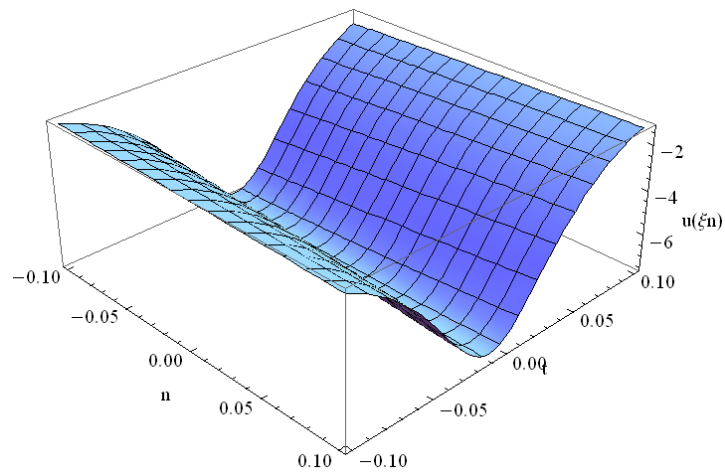
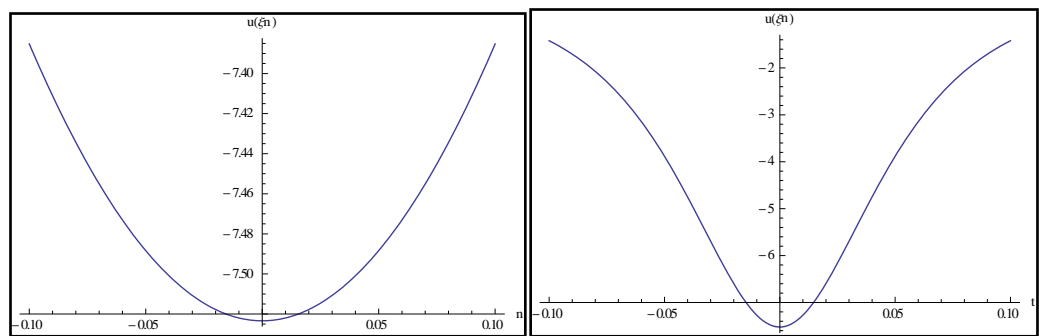

Figure 2.5 Plot 3D representation of $u_n[n, t] = u^-[\zeta_n]$ and $\alpha=4$, $\beta=1$, $d=1$ and $\zeta_0 = 0$



for t=0

for n=0

Figure 2.6 Plot 2D representation of $u_n[n, t] = u^-\left[\zeta_n\right]$ and $\alpha=4, \beta=1, d=1$ and $\zeta_0 = 0$.

Case 4: for $\varphi(\zeta_n) = \cosh(\zeta_n)$, Eq. (2.9) becomes

$$u(\zeta_n) = \frac{a + b \cosh^2(\zeta_n)}{j + \cosh^2(\zeta_n)} \quad (2.29)$$

Therefore

$$\cosh(\zeta_n \pm d) = \cosh(\zeta_n) \cosh(d) + \sinh(\zeta_n) \sinh(d) \quad (2.30)$$

So that we have

$$\begin{cases} u(\zeta_{n+1}) = \frac{a + b(\cosh(\zeta_n) \cosh(d) + \sinh(\zeta_n) \sinh(d))^2}{j + (\cosh(\zeta_n) \cosh(d) + \sinh(\zeta_n) \sinh(d))^2} \\ u(\zeta_{n-1}) = \frac{a + b(\cosh(\zeta_n) \cosh(d) - \sinh(\zeta_n) \sinh(d))^2}{j + (\cosh(\zeta_n) \cosh(d) - \sinh(\zeta_n) \sinh(d))^2} \end{cases} \quad (2.31)$$

and

$$u'(\zeta_n) = \frac{2(-a + bj) \cosh(\zeta_n) \sinh(\zeta_n)}{(j + \cosh^2(\zeta_n))^2} \quad (2.32)$$

Substitution of (2.29), (2.31), (2.32) in Eq. (2.8), then we have the system

$$\begin{cases} -c - 2cj - cj^2 + (2c + 2cj) \cosh^2(d) - c \cosh^4(d) \\ + (2a^2 + 2j^2\alpha + 2aj\beta) \cosh(d) \sinh(d) = 0, \\ 2c + 2cj - (2c + 4cj) \cosh^2(d) + (4ab + 4j\alpha + 2a\beta + 2bj\beta) \cosh(d) \sinh(d) = 0, \\ -c + (2b^2 + 2\alpha + 2b\beta) \cosh(d) \sinh(d) = 0, \end{cases} \quad (2.33)$$

With the aid of computer symbolic software Mathematica and solve it, we can obtain the solitary solutions:

$$u^\pm(\zeta_n) = \frac{\frac{\beta}{2} \pm \sqrt{(-4\alpha + \beta^2)(\cosh^2(d) - \cosh^4(d)) - \beta \cosh^2(\zeta_n)}}{-1 + 2 \cosh^2(\zeta_n)} \quad (2.34)$$

Where $\zeta_n = nd + 0.5(4\alpha - \beta^2)\cosh(d)\sinh(d)t + \zeta_0$, and the solutions Eq. (2.34) are shown in the Figure (2.7) for the physical wave $u_n[n, t] = u^+[\zeta_n]$, and Figure (2.8) for the physical wave $u_n[n, t] = u^-[\zeta_n]$.

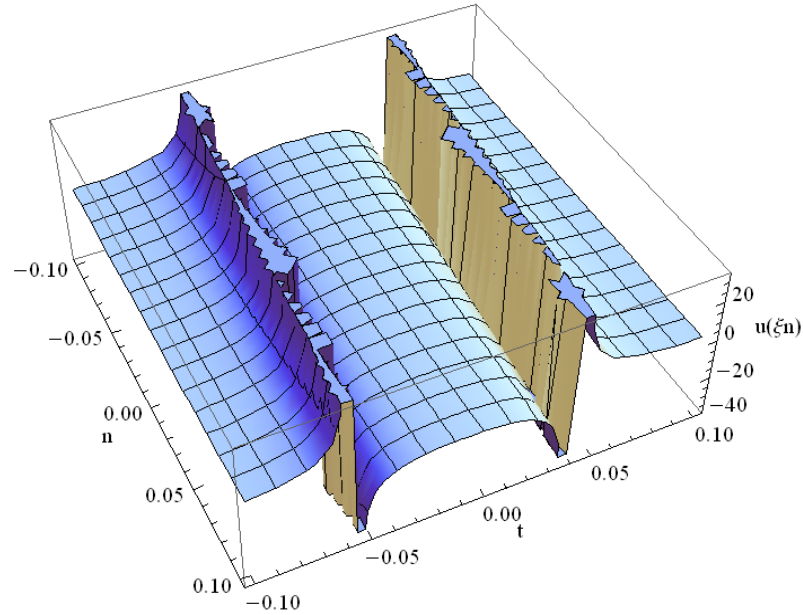

Figure 2.7 Plot 3D representation of $u_n[n, t] = u^+[\zeta_n]$ and $\alpha=4, \beta=1, d=1$ and $\zeta_0 = 0$

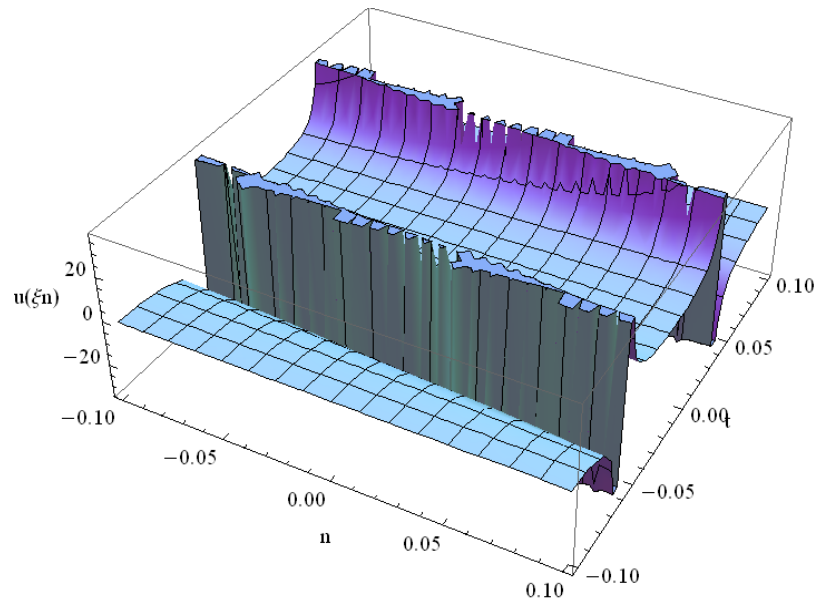

Figure 2.8 Plot 3D representation of $u_n[n, t] = u^-[\zeta_n]$ and $\alpha = 4, \beta = 1, d = 1$ and $\zeta_0 = 0$

Case 5: Doubly periodic wave (Jacobian elliptic function) solutions,

We consider now that $\varphi(\zeta_n) = cn(\zeta_n, m)$, Eq. (2.9) becomes:

$$u(\zeta_n) = \frac{a + b \operatorname{cn}^2(\zeta_n, m)}{j + \operatorname{cn}^2(\zeta_n, m)} \quad (2.35)$$

where a and b and j are constants to be determined later, and m is a modulus of Jacobi elliptic; if $m = 0, \operatorname{cn}^2(\zeta_n, m) = \cos^2(\zeta_n)$, The above also has localized soliton solutions

for $m = 1, \operatorname{cn}^2(\zeta_n, m) = \operatorname{sech}^2(\zeta_n)$, thus we have two types of solution.

The first type: If $m = 0$, so $\operatorname{cn}^2(\zeta_n, m) = \cos^2(\zeta_n)$, Eq. (2.35) becomes:

$$u(\zeta_n) = \frac{a + b \cos^2(\zeta_n)}{j + \cos^2(\zeta_n)} \quad (2.36)$$

We write the following practical expression

$$\cos(\zeta_n \pm d) = \cos(\zeta_n) \cos(d) \mp \sin(\zeta_n) \sin(d) \quad (2.37)$$

We get

$$\begin{cases} u(\zeta_{n+1}) = \frac{a + b(\cos(\zeta_n) \cos(d) + \sin(\zeta_n) \sin(d))^2}{j + (\cos(\zeta_n) \cos(d) + \sin(\zeta_n) \sin(d))^2} \\ u(\zeta_{n-1}) = \frac{a + b(\cos(\zeta_n) \cos(d) - \sin(\zeta_n) \sin(d))^2}{j + (\cos(\zeta_n) \cos(d) - \sin(\zeta_n) \sin(d))^2} \end{cases} \quad (2.38)$$

And

$$u'(\zeta_n) = \frac{2(-a + bj) \cos(\zeta_n) \sin(\zeta_n)}{(j + \cos^2(\zeta_n))^2} \quad (2.39)$$

Substitution of (2.39), (2.38), (2.37) in Eq. (2.8), and with the help of Mathematica we get a system of algebraic equations with respect to a , b , j and c :

$$\begin{cases} c + 2cj + cj^2 + (-2c - 2cj) \cos^2(d) + c \cos^4(d) \\ + (2a^2 + 2j^2\alpha + 2aj\beta) \cos(d) \sin(d) = 0, \\ -2c - 2cj + (2c + 4cj) \cosh^2(d) + (4ab + 4j\alpha + 2a\beta + 2bj\beta) \cos(d) \sin(d) = 0, \\ c + (2b^2 + 2\alpha + 2b\beta) \cos(d) \sin(d) = 0, \end{cases} \quad (2.40)$$

Solving this system, we get the periodic solutions that can be expressed in the following formulas

$$u^\pm(\zeta_n) = \frac{\frac{\beta}{2} \pm \sqrt{(-4\alpha + \beta^2)(\cos^2(d) - \cos^4(d)) - \beta \cos^2(\zeta_n)}}{-1 + 2 \cos^2(\zeta_n)} \quad (2.41)$$

where $\zeta_n = nd - 0.5(4\alpha - \beta^2) \cos(d) \sin(d)t + \zeta_0$

Finally, the fifth case admit the following two types of the traveling wave solutions

$$u^\pm(\zeta_n) = \frac{\frac{\beta}{2} \pm \sqrt{(-4\alpha + \beta^2)(\cos^2(d) - \cos^4(d)) - \beta \cos^2(\zeta_n, m)}}{-1 + 2 \cos^2(\zeta_n, m)} \quad (2.42)$$

The second type: If $m=1$ so $cn^2(\zeta_n, m) = \text{sech}^2(\zeta_n)$, Eq. (2.35) becomes:

$$u(\zeta_n) = \frac{a + b \text{sech}^2(\zeta_n)}{j + \text{sech}^2(\zeta_n)} \quad (2.43)$$

We write the following practical expression

$$\operatorname{sech}(\zeta_n \pm d) = 1 / \cosh(\zeta_n) \cosh(d) \pm \sinh(\zeta_n) \sinh(d) \quad (2.44)$$

we get

$$\begin{cases} u(\zeta_{n+1}) = \frac{a + b(\cosh(\zeta_n) \cosh(d) + \sinh(\zeta_n) \sinh(d))^{-2}}{j + (\cosh(\zeta_n) \cosh(d) + \sinh(\zeta_n) \sinh(d))^{-2}} \\ u(\zeta_{n-1}) = \frac{a + b(\cosh(\zeta_n) \cosh(d) - \sinh(\zeta_n) \sinh(d))^{-2}}{j + (\cosh(\zeta_n) \cosh(d) - \sinh(\zeta_n) \sinh(d))^{-2}} \end{cases} \quad (2.45)$$

and

$$u'(\zeta_n) = \frac{2(-a + bj) \operatorname{sech}^2(\zeta_n) \tanh(\zeta_n)}{(1 + j \operatorname{sech}^2(\zeta_n))^2} \quad (2.46)$$

Substitution of (2.43), (2.45), (2.46) in Eq. (2.8), and with the help of Mathematica and after transformation, we get a system of algebraic equations with respect to a , b , j and c :

$$\begin{cases} c + 2cj + cj^2 + (-2c - 2cj) \operatorname{sech}^2(d) + c \operatorname{sech}^4(d) \\ + (2a^2 + 2j^2\alpha + 2aj\beta) \operatorname{sech}(d) \operatorname{csch}(d) = 0, \\ -2c - 2cj + (2c + 4cj) \operatorname{sech}^2(d) \\ + (4ab + 4j\alpha + 2a\beta + 2bj\beta) \operatorname{sech}(d) \operatorname{csch}(d) = 0, \\ c + (2b^2 + 2\alpha + 2b\beta) \operatorname{sech}(d) \operatorname{csch}(d) = 0, \end{cases} \quad (2.47)$$

Solving this system, we get the periodic solutions that can be expressed in the following formulas

$$u^\pm(\zeta_n) = \frac{\frac{\beta}{2} \pm \sqrt{(-4\alpha + \beta^2)(\operatorname{sech}^2(d) - \operatorname{sech}^4(d)) - \beta \operatorname{sech}^2(\zeta_n)}}{-1 + 2\operatorname{sech}^2(\zeta_n)} \quad (2.48)$$

where

$$\zeta_n = nd - 0.5(4\alpha - \beta^2)\operatorname{sech}(d)\operatorname{csch}(d)t + \zeta_0$$

Graphically, we illustrate the solutions Eq. (2.48) in the Figure (2.9), the physical wave $u_n[n, t] = u^+[\xi_n]$ and in the Figure (2.10), the physical wave $u_n[n, t] = u^-[\xi_n]$.

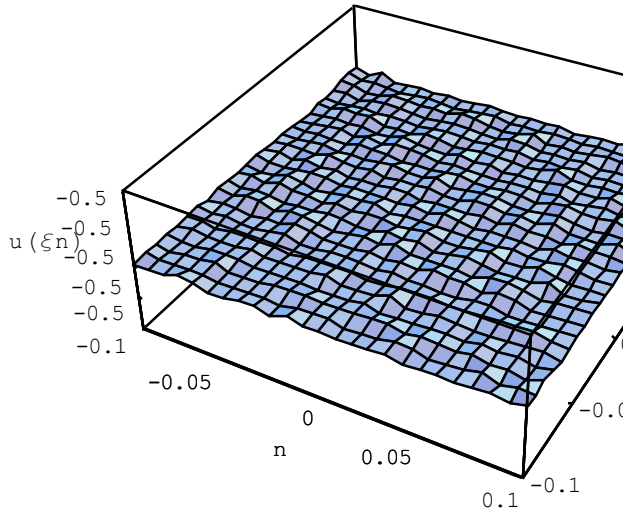

Figure 2.9 Plot 3D representation of $u_n[n, t] = u^+[\xi_n]$ and $\alpha=1$, $\beta=4$, $d=1$ and $\zeta_0 = 0$

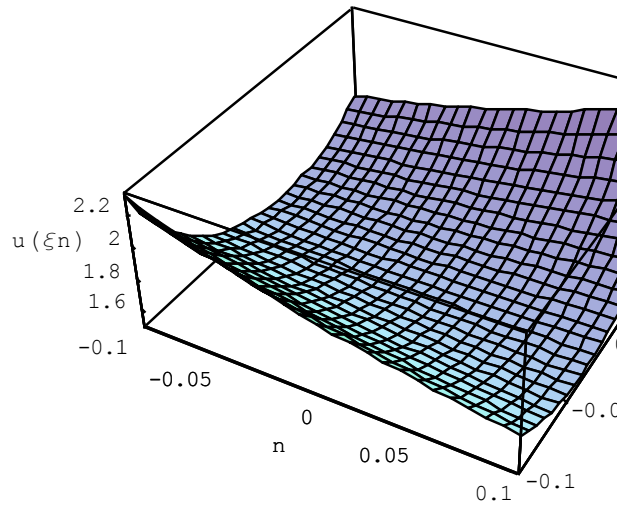

Figure 2.10 Plot 3D representation of $u_n[n, t] = u^-\left[\xi_n\right]$ and $\alpha=1, \beta=4, d=1$ and $\zeta_0 = 0$

Finally, the fifth case admit the following two types of the traveling wave solutions

$$u^\pm(\xi_n, m) = \frac{\frac{\beta}{2} \pm \sqrt{(-4\alpha + \beta^2)(cn^2(d, m) - cn^4(d, m)) - \beta cn^2(\xi_n, m)}}{-1 + 2cn^2(\xi_n, m)} \quad (2.49)$$

Remark

A novel class of explicit exact solutions to nonlinear equations can be derived from fractional transformations methods or an **extended auxiliary fractional shape** (Exafs) using a non singular combination of these functions as:

$$u(\xi) = \frac{\alpha_0 + \sum_{k=1}^M \alpha_k F^k(\xi)}{F^{M/2}(\xi)} \quad (2.50)$$

where F is a known appropriate function.

2.4 Discussion and conclusion

In conclusion, we have obtained many types of fractional solutions of the nonlinear lattice equation by using fractional transformations. The fifth cases are used to find the exact solutions; these solutions include the symmetrical rational solutions, the symmetrical periodic wave solutions, the symmetrical solitary wave solutions, and the symmetrical Jacobi elliptic function solutions.

This method has more advantages: it is direct and concise. The availability of computer systems like Mathematica facilitates the tedious algebraic calculations and complexes. In the other hand, the fractional transformations method has disadvantages : each supposed type a fractional solution to give two the symmetrical solutions when we Compare it to the solutions of coth-csch method which it is effective for giving more solutions.

The fractional transformations method which we have proposed in this chapter is also direct and computerizable method, which allows us to obtain the exact traveling wave solutions of nonlinear equation; these solutions may be useful to further understanding of the nonlinear lattice equation. In addition, these transformations can be also applied to other types of nonlinear wave equations.

References

- [1] E. T. Whittaker , G.N. Watson. A course of modern analysis. Fourth ed. Cambridge: Cambridge University Press, 1952.
- [2] T. Solomon Raju, C. Nagaraja Kumar, P. Panigrahi , On exact solitary wave solutions of the nonlinear Schroedinger equation with a source, Journal of physics a: mathematical and general, 2005, vol 38 , 271–1276.
- [3] D.J. Kaup, A.C. Newell, Proc. R. Soc. Lond. A , 1978, 361- 413
- [4] R.M . Miura , J. Math. Phys , 1968, vol 9, 1202
- [5] P.S. Lomdahl , M.R. Samuelsen , Phys. Rev. A, 1986, vol 34, 664.
- [6] D. J. Kaup , A. C. Newell, Phys. Rev. B , 1978, vol 18 , 5162.
- [7] K. Nozaki , N. Bekki , Phys. Rev. Lett, 1983, vol 50 , 1226.
- [8] K. Nozaki, N. Bekki N, Physica D, 1986, vol 21 , 381.
- [9] L. Friedland , A.G. Shagalov , Phys. Rev. Lett, 1998, vol 81 , 4357.
- [10] L. Friedland , Phys. Rev. E , 1998, vol 58 , 3865
- [11] G. B. Whitham , Linear, and Nonlinear Waves (New York: Wiley), 1974.
- [12] S.V. Novikov , S. V. Manakov , L. P. Pitaevsky , V.E. Zakharov , Theory of solitons. the inverse scattering method , (New York: Consultants Bureau) and references therein, 1984.
- [13] A . Das, Integrable Models, (Singapore: World Scientific), 1989 .
- [14] P. G. Drazin , R. S. Johnson , Solitons : An introduction (Cambridge: Cambridge University Press), 1989.

- [15] Z. Yan, Envelope exact solutions for the generalized nonlinear Schroedinger equation with a source, *J. Phys. A: Math. Gen*, 2006, vol 39 , L401–L406
- [16] M.J. Ablowitz, P.A. Clarkson, *Solitons Nonlinear Evolution Equations and Inverse Scattering* (Cambridge: Cambridge University Press), 1991.
- [17] M. J. Ablowitz, H. Segur, *Solitons and Inverse Scattering Transformation* (Philadelphia: SIAM), 1981 .
- [18] P. G Drazin, R. S. Johnson, *Solitons An Introduction*, (Cambridge: Cambridge University Press), 1989.
- [19] P. G. Agrawal, *Nonlinear Fiber Optics* (New York: Academic), 1989 .
- [20] Z. Yan, *Chaos Solitons Fractals* , 2005, vol 23, 767
- [21] Z. Yan , *Phys. Lett. A*, 2001, vol 292, 100.
- [22] Wei. Gui Feng, Li. Kai-Ming , Li. Ya-Zhou, Chang Lin, Explicit exact solutions for (2 +1)-dimensional Boiti–Leon–Pempinelli equation, *Commun Nonlinear Sci Numer Simulat*, 2009, vol 14, 2013–2017.

Chapter 3

Symbolic computational of nonlinear wave equation with constant coefficients via the functional variable method

3.1 Introduction

The recent developments of nonlinear problems with intense effort increased the need of constructing new approaches. In this section we will deal with direct treatment of the construction of exact solutions for a number of nonlinear wave equations via the Functional Variable Method. In this chapter, we will use the functional variable method for solving the generalized one-dimensional of the Benjamin–Bona–Mahony (BBM) equations for every order to find the exact solutions.

Exact solutions not only certify whether the obtained numerical solutions are better, but also are used to watch the mathematical rule of the wave by making the graphs of the exact solutions. This is due to the complexity of nonlinear wave equations, see ref [1–7].

In the coming pages, firstly, we describe a new development based on the functional variable method to find the exact solutions for a family of nonlinear wave equations. Afterwards, we will examine some applications together with the help of symbolic software like the Mathematica [8–17].

For showing the effectiveness of this method, We treat some of non-linear equations structures with constant coefficients, and we treat also the effect of the negative exponent of nonlinear terms.

3.2 Formulation of the method

We describe the method of the functional variable (MVF) [18,19] which led to the integration of several models of nonlinear partial differential equations PDE. Let us consider the following nonlinear partial differential equation, written in several independent variables:

$$P(u, u_x, u_y, u_z, u_{xy}, u_{yz}, u_{xz}, u_{xx}, \dots) = 0 \quad (1.1)$$

Where P the subscript which denotes partial derivative to some function ,and $u(t, x, y, z, \dots)$ is called a dependent variable or unknown function to be determined later.

We firstly introduce the new wave variable as

$$\xi = \sum_{i=0}^p \alpha_i \chi_i + \xi_0 \quad (1.2)$$

When $p = 1, \xi = \xi_0 + \alpha_0 \chi_0 + \alpha_1 \chi_1$, the parameters α_0, α_1 are identified as the wave pulsation ω and the wave vector k respectively if χ_0, χ_1 are the variables t and x respectively.

We introduce the following transformation for a travelling wave solution of Eq.(3.1)

$$u(\chi_0, \chi_1, \dots) = u(\xi) \quad (1.3)$$

And the chain rule

$$\frac{\partial}{\partial \chi_i} (\cdot) = \alpha_i \frac{d}{d\xi} (\cdot), \frac{\partial^2}{\partial \chi_i \partial \chi_j} (\cdot) = \alpha_i \alpha_j \frac{d^2}{d\xi^2} (\cdot), \dots \quad (3.4)$$

By using these transformations, the nonlinear partial differential (3.1) can be converted to an ordinary differential equation ODE like

$$Q(u, u_\xi, u_{\xi\xi}, u_{\xi\xi\xi}, u_{\xi\xi\xi\xi}, \dots) = 0 \quad (3.5)$$

Let us make a transformation in which the unknown function u is considered as a functional variable in the form

$$u_\xi = F(u) \quad (3.6)$$

and some successively derivatives of u are

$$\begin{aligned} u_{\xi\xi} &= \frac{1}{2}(F^2)', u_{\xi\xi\xi} = \frac{1}{2}(F^2)''\sqrt{F^2}, \\ u_{\xi\xi\xi\xi} &= \frac{1}{2}[(F^2)'''F^2 + (F^2)''(F^2)'] \end{aligned} \quad (3.7)$$

where ‘ \prime ’ stands for $\frac{d}{du}$. The ODE (3.5) can be reduced in terms of u, F and its derivatives upon using the expressions of Eq. (3.7) and (3.6) into Eq. (3.5) gives

$$R(u, F, F', F'', F''', \dots) = 0 \quad (3.8)$$

The key idea of this particular form Eq.(3.8) is of special interest because it admits analytical solutions for a large class of nonlinear wave type equations. After integration, the Eq. (3.8) provides the expression of F and this in turn together with Eq. (3.7) gives the relevant solutions to the original problem.

In order to illustrate how the method works we examine some examples treated by other approaches. This matter is exposed in the following section.

3.3 Application

The BBM equation is a model that characterizes long waves in nonlinear dispersive. It describes an approximation for surface water waves in a uniform channel. Moreover, the BBM equation covers also, in addition to the surface waves of long wavelength in liquids, hydromagnetic waves in cold plasma, acoustic waves in anharmonic crystals, and acoustic gravity waves in compressible fluids [20].

So, we apply the results obtained earlier in the generalized form of the Benjamin–Bona–Mahoney (BBM) for every order [20] as follows:

$$\left(u^n\right)_t - \left(u^n\right)_{xxx} + a\left(u^m\right)_x = 0, n > m > 1 \quad (3.9)$$

and negative exponents

$$\left(u^{-n}\right)_t - \left(u^{-n}\right)_{xxx} + a\left(u^m\right)_x = 0, n > m > 1 \quad (3.10)$$

a generalized form of the BBM equation

$$\left(u^n\right)_t + \left(u^n\right)_x - \left(u^n\right)_{xxx} + a(m+1)u^m\left(u\right)_x = 0, n > m > 1 \quad (3.11)$$

and negative exponents

$$\left(u^{-n}\right)_t + \left(u^{-n}\right)_x - \left(u^{-n}\right)_{xxx} + a(m+1)u^m\left(u\right)_x = 0, n > m > 1 \quad (3.12)$$

Equations (3.9) – (3.12) were studied by Wazwaz [1] using the sine-cosine method to obtain compactons, solitary wave solutions and solitary periodic patterns.

3.3.1 Benjamin-Bona-Mahony (BBM) equation

The aim of the present work is to obtain travelling wave solutions of distinct physical structures for the BBM equation and its variants given by

Case 1: If $\xi = x - ct + \xi_0$ and $v = u^m$ Eq. (3.9) becomes the ODE

$$-c\left(v^{\frac{n}{m}}\right)_\xi - \left(v^{\frac{n}{m}}\right)_{\xi\xi\xi} + \alpha\left(v\right)_\xi = 0 \quad (3.13)$$

The parameters α , c are identified as the constant and the velocity respectively. Integrating the system (3.13) once with respect to ξ , setting the constants of integration to zero, and combining both equations yields the simplified form

$$-\frac{cm}{n+m}\left(v^{\frac{n}{m}+1}\right) - \frac{1}{2}\left(\left(v^{\frac{n}{m}}\right)_\xi\right)^2 + \frac{\alpha}{2}\left(v^2\right) = 0 \quad (3.14)$$

According to Eq. (3.7), we get from Eq. (3.14) the expression of the function $F(U)$ reads

$$F = v\sqrt{\alpha} \sqrt{1 - \frac{2cv^{-1+\frac{n}{m}}}{\alpha(1+\frac{n}{m})}} \quad (3.15)$$

By virtue of Eq. (3.15), the differential Eq. (3.6) is completely integrable, since its solutions are deduced directly from the integral.

$$\int \frac{dy}{y\sqrt{1-y}} = \ln \left| \frac{1-\sqrt{1-y}}{1+\sqrt{1-y}} \right| \quad (3.16)$$

In view of Eq. (3.6) and the relation Eq. (3.16), we can easily obtain the following quadratic equation

$$A^2Z^2 + 4(1-A^2)Z - 4(1-A^2) = 0 \quad (3.17)$$

where

$$A = \frac{2 \tan^2 \left[\frac{1}{2} \left(-1 + \frac{n}{m} \right) \sqrt{\alpha} \xi \right]}{1 + \tan^2 \left[\frac{1}{2} \left(-1 + \frac{n}{m} \right) \sqrt{\alpha} \xi \right]} \quad (3.18)$$

and

$$Z = \frac{2cv^{-1+\frac{n}{m}}}{\left(1 + \frac{n}{m}\right)\alpha} \quad (3.19)$$

The two solutions of the above system Eq. (3.17) follow, after some simple algebraic manipulation

For $\alpha > 0$:

$$v_1[\xi] = 2^{-\frac{1}{-1+\frac{n}{m}}} \left(\frac{(1 + \frac{n}{m})\alpha \operatorname{sech}^2[\frac{1}{2}(-1 + \frac{n}{m})\sqrt{\alpha}\xi]}{c} \right)^{\frac{1}{-1+\frac{n}{m}}} \quad (3.20)$$

$$v_2[\xi] = 2^{-\frac{1}{-1+\frac{n}{m}}} \left(-\frac{(1 + \frac{n}{m})\alpha \operatorname{csch}^2[\frac{1}{2}(-1 + \frac{n}{m})\sqrt{\alpha}\xi]}{c} \right)^{\frac{1}{-1+\frac{n}{m}}} \quad (3.21)$$

For $\alpha < 0$:

$$v_1[\xi] = 2^{-\frac{1}{-1+\frac{n}{m}}} \left(\frac{(1 + \frac{n}{m})\alpha \operatorname{sec}^2[\frac{1}{2}(-1 + \frac{n}{m})\sqrt{-\alpha}\xi]}{c} \right)^{\frac{1}{-1+\frac{n}{m}}} \quad (3.22)$$

$$v_2[\xi] = 2^{-\frac{1}{-1+\frac{n}{m}}} \left(-\frac{(1 + \frac{n}{m})\alpha \operatorname{csc}^2[\frac{1}{2}(-1 + \frac{n}{m})\sqrt{-\alpha}\xi]}{c} \right)^{\frac{1}{-1+\frac{n}{m}}} \quad (3.23)$$

We have $u[\xi] = v^{\frac{1}{m}}[\xi]$, so :

For $\alpha > 0$: we obtain the following the solitary solutions

$$u_1[\xi] = 2^{-\frac{1}{n-m}} \left(\frac{(1 + \frac{n}{m})\alpha \operatorname{sech}^2[\frac{1}{2}(-1 + \frac{n}{m})\sqrt{\alpha}\xi]}{c} \right)^{\frac{1}{n-m}} \quad (3.24)$$

$$u_2[\xi] = 2^{-\frac{1}{n-m}} \left(-\frac{(1 + \frac{n}{m})\alpha \operatorname{csch}^2[\frac{1}{2}(-1 + \frac{n}{m})\sqrt{\alpha}\xi]}{c} \right)^{\frac{1}{n-m}} \quad (3.25)$$

for $\alpha < 0$: we obtain the periodic solutions

$$u_1[\xi] = 2^{-\frac{1}{n-m}} \left(\frac{(1 + \frac{n}{m})\alpha \sec^2[\frac{1}{2}(-1 + \frac{n}{m})\sqrt{-\alpha}\xi]}{c} \right)^{\frac{1}{n-m}} \quad (3.26)$$

$$u_2[\xi] = 2^{-\frac{1}{n-m}} \left(-\frac{(1 + \frac{n}{m})\alpha \csc^2[\frac{1}{2}(-1 + \frac{n}{m})\sqrt{-\alpha}\xi]}{c} \right)^{\frac{1}{n-m}} \quad (3.27)$$

Graphically, we show on Fig. (3.1), and Fig. (3.2), the formation of solitary solutions $u_1[\xi]$ for $\alpha > 0$.

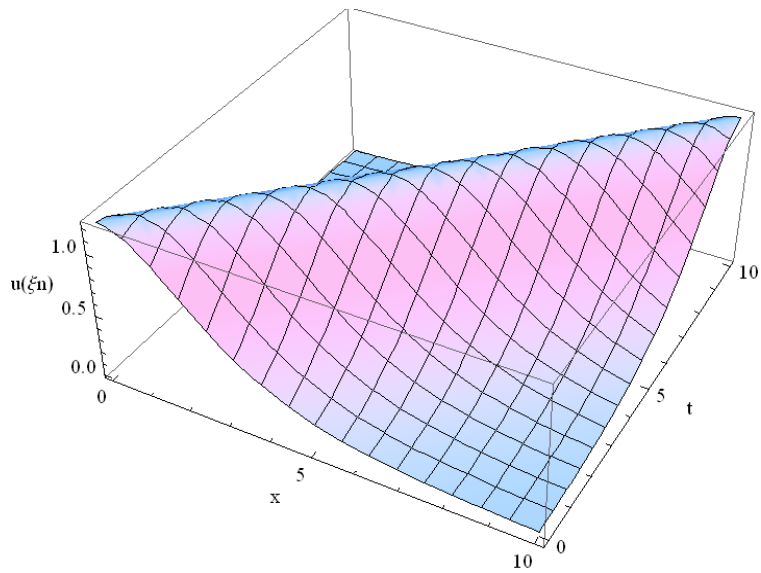
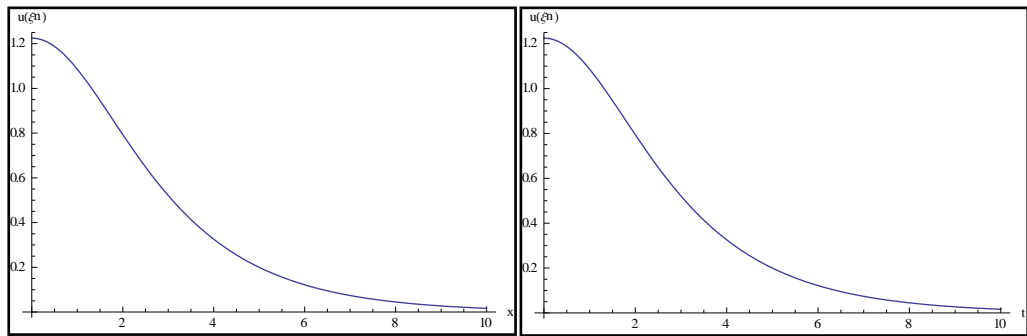

Figure 3.1 Plot 3D representation of Eq. (3.24) for both curves:
 $n = 4, m = 2, \alpha = 1, c = 1$ and $\xi_0 = 0$



for $t = 0$

for $x = 0$

Figure 3.2 Plot 2D representation of Eq. (3.24) and $n = 4, m = 2, \alpha = 1, c = 1$,
and $\xi_0 = 0$

Case 2: We have $\xi = x - ct + \xi_0$ and $v = u^n$ Eq. (3.9) becomes the ODE

$$-c(v)_\xi - (v)_{\xi\xi\xi} + \alpha(v^{\frac{m}{n}})_\xi = 0 \quad (3.28)$$

after twice integral we obtain

$$F = v\sqrt{c} \sqrt{-1 + \frac{2\alpha v^{-1+\frac{m}{n}}}{c(1 + \frac{m}{n})}} \quad (3.29)$$

In the same method and by virtue of Eq. (3.29), the differential Eq. (3.6) is completely integrable, since its solutions are deduced directly from the integral

$$\int \frac{dy}{y\sqrt{1-y}} = \ln \left| \frac{1 - \sqrt{1-y}}{1 + \sqrt{1-y}} \right| \quad (3.30)$$

By Eq. (3.6) and the relation Eq. (3.30), we can obtain the following quadratic equation

$$A^2 Z^2 + 4(1 - A^2)Z - 4(1 - A^2) = 0, \quad (3.31)$$

where

$$A = \frac{2 \tan^2 \left[\frac{1}{2} \left(-1 + \frac{m}{n} \right) \sqrt{c\xi} \right]}{1 + \tan^2 \left[\frac{1}{2} \left(-1 + \frac{m}{n} \right) \sqrt{c\xi} \right]} \quad (3.32)$$

and

$$z = \frac{2\alpha v^{-1+\frac{m}{n}}}{c(1 + \frac{m}{n})} \quad (3.33)$$

The two solutions of the above system Eq. (3.31) follow, after some simple algebraic manipulation

For $c > 0$

$$v_1[\xi] = 2^{-\frac{n}{m-n}} \left(\frac{c(1 + \frac{m}{n}) \operatorname{sech}^2[\frac{1}{2}\sqrt{c}(-1 + \frac{m}{n})\xi]}{\alpha} \right)^{\frac{n}{m-n}} \quad (3.34)$$

$$v_2[\xi] = 2^{-\frac{n}{m-n}} \left(-\frac{c(1 + \frac{m}{n}) \operatorname{csch}^2[\frac{1}{2}\sqrt{c}(-1 + \frac{m}{n})\xi]}{\alpha} \right)^{\frac{n}{m-n}} \quad (3.35)$$

For $c > 0$:

$$v_1[\xi] = 2^{-\frac{n}{m-n}} \left(\frac{c(1 + \frac{m}{n}) \operatorname{sec}^2[\frac{1}{2}\sqrt{-c}(-1 + \frac{m}{n})\xi]}{\alpha} \right)^{\frac{n}{m-n}} \quad (3.36)$$

$$v_2[\xi] = 2^{-\frac{n}{m-n}} \left(-\frac{c(1 + \frac{m}{n}) \operatorname{csc}^2[\frac{1}{2}\sqrt{-c}(-1 + \frac{m}{n})\xi]}{\alpha} \right)^{\frac{n}{m-n}} \quad (3.37)$$

We have $u[\xi] = v[\xi]^{\frac{1}{n}}$, so:

For $c > 0$: we obtain the following the solitary solutions

$$u_1[\xi] = 2^{-\frac{1}{m-n}} \left(\frac{c(1 + \frac{m}{n}) \operatorname{sech}^2[\frac{1}{2}\sqrt{c}(-1 + \frac{m}{n})\xi]}{\alpha} \right)^{\frac{1}{m-n}} \quad (3.38)$$

$$u_2[\xi] = 2^{-\frac{1}{m-n}} \left(\frac{c(1 + \frac{m}{n}) \operatorname{csch}^2 \left[\frac{1}{2} \sqrt{c} \left(-1 + \frac{m}{n} \right) \xi \right]}{\alpha} \right)^{\frac{1}{m-n}} \quad (3.39)$$

For $c < 0$: we obtain the following the periodic solutions

$$u_1[\xi] = 2^{-\frac{1}{m-n}} \left(\frac{c(1 + \frac{m}{n}) \sec^2 \left[\frac{1}{2} \sqrt{-c} \left(-1 + \frac{m}{n} \right) \xi \right]}{\alpha} \right)^{\frac{1}{m-n}} \quad (3.40)$$

$$u_2[\xi] = 2^{-\frac{1}{m-n}} \left(\frac{c(1 + \frac{m}{n}) \csc^2 \left[\frac{1}{2} \sqrt{-c} \left(-1 + \frac{m}{n} \right) \xi \right]}{\alpha} \right)^{\frac{1}{m-n}} \quad (3.41)$$

3.3.2 Equation Benjamin-Bona-Mahony (BBM) with negative exponents

For more clarity the method function variable applies on Benjamin-Bona-Mahony (BBM) equation with negative exponents as following form:

Case 1: $\xi = x - ct + \xi_0$ and $v = u^{-n}$ Eq. (3.10) becomes the ODE

$$-c(v)_\xi - (v)_{\xi\xi\xi} + \alpha(v)^{\frac{m}{n}}_\xi = 0 \quad (3.42)$$

In the same method and after some simple algebraic manipulation we obtain the following solutions.

For $c > 0$:

$$v_1[\xi] = 2^{\frac{n}{m+n}} \left(\frac{c(1 - \frac{m}{n}) \operatorname{sech}^2[\frac{1}{2} \sqrt{c}(-1 - \frac{m}{n})\xi]}{\alpha} \right)^{\frac{-n}{m+n}} \quad (3.43)$$

$$v_2[\xi] = 2^{\frac{n}{m+n}} \left(-\frac{c(1 - \frac{m}{n}) \operatorname{csch}^2[\frac{1}{2} \sqrt{c}(-1 - \frac{m}{n})\xi]}{\alpha} \right)^{\frac{-n}{m+n}} \quad (3.44)$$

For $c < 0$:

$$v_1[\xi] = 2^{\frac{n}{m+n}} \left(\frac{c(1 - \frac{m}{n}) \operatorname{sec}^2[\frac{1}{2} \sqrt{-c}(-1 - \frac{m}{n})\xi]}{\alpha} \right)^{\frac{-n}{m+n}} \quad (3.45)$$

$$v_2[\xi] = 2^{\frac{n}{m+n}} \left(-\frac{c(1 - \frac{m}{n}) \operatorname{csc}^2[\frac{1}{2} \sqrt{-c}(-1 - \frac{m}{n})\xi]}{\alpha} \right)^{\frac{-n}{m+n}} \quad (3.46)$$

We have $u[\xi] = v[\xi]^{\frac{1}{n}}$, so,

For $c > 0$: we obtain the following the solitary solutions

$$u_1[\xi] = 2^{\frac{-1}{m+n}} \left(\frac{c(1 - \frac{m}{n}) \operatorname{sech}^2[\frac{1}{2} \sqrt{c}(-1 - \frac{m}{n})\xi]}{\alpha} \right)^{\frac{1}{m+n}} \quad (3.47)$$

$$u_2[\xi] = 2^{\frac{-1}{m+n}} \left(\frac{c(1 - \frac{m}{n}) \operatorname{csch}^2[\frac{1}{2} \sqrt{c}(-1 - \frac{m}{n})\xi]}{\alpha} \right)^{\frac{1}{m+n}} \quad (3.48)$$

For $c < 0$: we obtain the following the periodic solutions

$$u_1[\xi] = 2^{\frac{-1}{m+n}} \left(\frac{c(1 - \frac{m}{n}) \sec^2[\frac{1}{2} \sqrt{-c}(-1 - \frac{m}{n})\xi]}{\alpha} \right)^{\frac{1}{m+n}} \quad (3.49)$$

$$u_2[\xi] = 2^{\frac{-1}{m+n}} \left(\frac{c(1 - \frac{m}{n}) \csc^2[\frac{1}{2} \sqrt{-c}(-1 - \frac{m}{n})\xi]}{\alpha} \right)^{\frac{1}{m+n}} \quad (3.50)$$

Case 2: If $\xi = x - ct + \xi_0$ and $v = u^m$ Eq. (3.10) becomes the ODE

$$-c(v^{\frac{-n}{m}})_\xi - (v^{\frac{-n}{m}})_{\xi\xi\xi} + \alpha(v)_\xi = 0 \quad (3.51)$$

After integrals and some simple algebraic manipulation we obtain two solutions.

For $\alpha > 0$:

$$v_1[\xi] = 2^{-\frac{1}{-1-\frac{n}{m}}} \left(\frac{(1 - \frac{n}{m})\alpha \operatorname{sech}^2[\frac{1}{2}(-1 - \frac{n}{m})\sqrt{\alpha}\xi]}{c} \right)^{\frac{1}{-1-\frac{n}{m}}} \quad (3.52)$$

$$v_2[\xi] = 2^{-\frac{1}{-1-\frac{n}{m}}} \left(-\frac{(1 - \frac{n}{m})\alpha \operatorname{csch}^2[\frac{1}{2}(-1 - \frac{n}{m})\sqrt{\alpha}\xi]}{c} \right)^{\frac{1}{-1-\frac{n}{m}}} \quad (3.53)$$

For $\alpha < 0$:

$$v_1[\xi] = 2^{-\frac{1}{-1-\frac{n}{m}}} \left(\frac{(1 - \frac{n}{m})\alpha \operatorname{sec}^2[\frac{1}{2}(-1 + \frac{n}{m})\sqrt{-\alpha}\xi]}{c} \right)^{\frac{1}{-1-\frac{n}{m}}}$$

(3.54)

$$v_2[\xi] = 2^{-\frac{1}{-1-\frac{n}{m}}} \left(-\frac{(1 - \frac{n}{m})\alpha \operatorname{csc}^2[\frac{1}{2}(-1 - \frac{n}{m})\sqrt{-\alpha}\xi]}{c} \right)^{\frac{1}{-1-\frac{n}{m}}} \quad (3.55)$$

We have $u[\xi] = v^{\frac{1}{m}}[\xi]$, so:

For $\alpha > 0$: we obtain the following the solitary solutions

$$u_1[\xi] = 2^{\frac{1}{n+m}} \left(\frac{(1 - \frac{n}{m})\alpha \operatorname{sech}^2[\frac{1}{2}(-1 - \frac{n}{m})\sqrt{\alpha}\xi]}{c} \right)^{\frac{-1}{n+m}} \quad (3.56)$$

$$u_2[\xi] = 2^{\frac{1}{n+m}} \left(-\frac{(1 - \frac{n}{m})\alpha \operatorname{csch}^2[\frac{1}{2}(-1 - \frac{n}{m})\sqrt{\alpha}\xi]}{c} \right)^{\frac{-1}{n+m}} \quad (3.57)$$

For $\alpha < 0$: we obtain the following the periodic solutions

$$u_1[\xi] = 2^{\frac{1}{n+m}} \left(\frac{(1 - \frac{n}{m})\alpha \sec^2[\frac{1}{2}(-1 - \frac{n}{m})\sqrt{-\alpha}\xi]}{c} \right)^{\frac{-1}{n+m}} \quad (3.58)$$

$$u_2[\xi] = 2^{\frac{1}{n+m}} \left(-\frac{(1 - \frac{n}{m})\alpha \csc^2[\frac{1}{2}(-1 - \frac{n}{m})\sqrt{-\alpha}\xi]}{c} \right)^{\frac{-1}{n+m}} \quad (3.59)$$

Graphically, we show on Fig. (3.3) and Fig. (3.4) the formation of periodic solutions $u_2[\xi]$ for $\alpha < 0$.

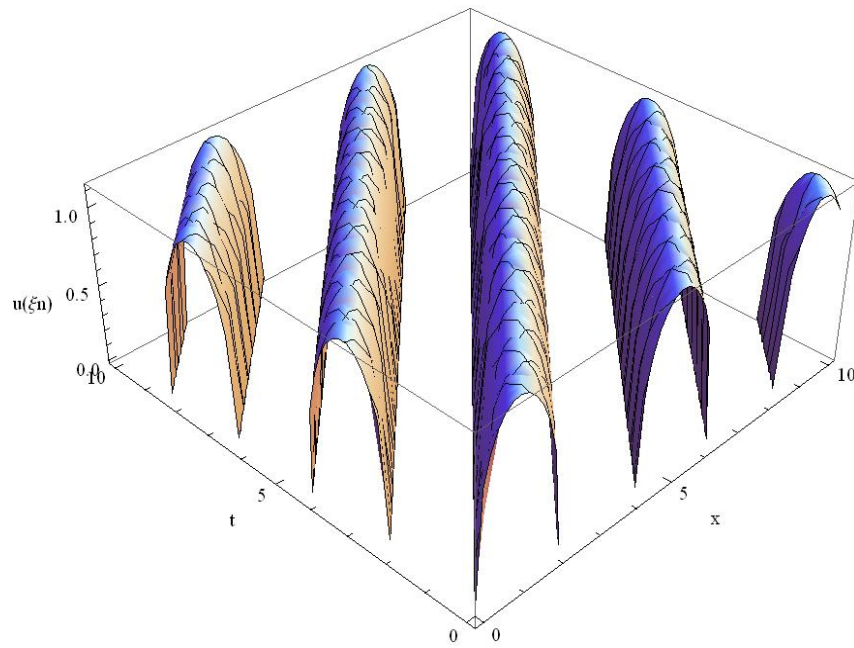
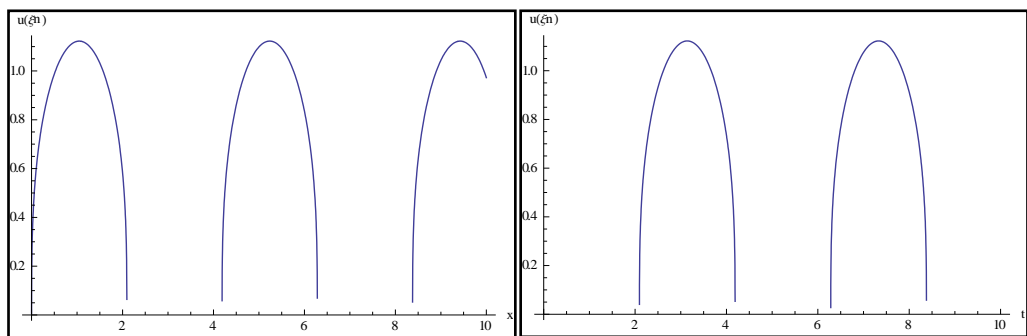

Figure 3.3 Plot 3D representation of Eq. (3.59) and $n = 4, m = 2, \alpha = -1, c = 1,$ and $\xi_0 = 0$



for $t = 0$

for $x = 0$

Figure 3.4 Plot 2D representation of Eq. (3.59) and $n = 4, m = 2, \alpha = -1, c = 1,$ and $\xi_0 = 0$

3.3.3 A generalized form of the BBM equation

For motivation work analytically and numerically we use our method on The complexity of the nonlinear wave equations of BBM, where the balance between the nonlinear convection term $u^m u_x$ and the dispersion effect term $(u^n)_{xxx}$, see ref [22]. We will search the exact solutions of nonlinear problem through cases as follows as.

Case 1: If $\xi = x - ct + \xi_0$ and $v = u^{m+1}$ Eq. (3.11) becomes the ODE

$$(-c + 1)(v^{\frac{n}{m+1}})_{\xi} - (v^{\frac{n}{m+1}})_{\xi\xi\xi} + \alpha(v)_{\xi} = 0 \quad (3.60)$$

after some simple algebraic manipulation we have the following solutions.

For $\alpha > 0$:

$$v_1[\xi] = \left(\frac{-\alpha\left(\frac{n}{m+1} + 1\right) \operatorname{sech}^2\left[\frac{1}{2}\sqrt{\alpha}\left(-1 + \frac{n}{m+1}\right)\xi\right]}{2(1-c)} \right)^{\frac{1}{\left(\frac{n}{m+1}-1\right)}} \quad (3.61)$$

$$v_2[\xi] = \left(\frac{\alpha\left(\frac{n}{m+1} + 1\right) \operatorname{csch}^2\left[\frac{1}{2}\sqrt{\alpha}\left(-1 + \frac{n}{m+1}\right)\xi\right]}{2(1-c)} \right)^{\frac{1}{\left(\frac{n}{m+1}-1\right)}} \quad (3.62)$$

For $\alpha < 0$:

$$v_1[\xi] = \left(\frac{-\alpha\left(\frac{n}{m+1} + 1\right) \operatorname{sec}^2\left[\frac{1}{2}\sqrt{-\alpha}\left(-1 + \frac{n}{m+1}\right)\xi\right]}{2(1-c)} \right)^{\frac{1}{\left(\frac{n}{m+1}-1\right)}} \quad (3.63)$$

$$v_2[\xi] = \left(\frac{\alpha\left(\frac{n}{m+1} + 1\right) \operatorname{csc}^2\left[\frac{1}{2}\sqrt{-\alpha}\left(-1 + \frac{n}{m+1}\right)\xi\right]}{2(1-c)} \right)^{\frac{1}{\left(\frac{n}{m+1}-1\right)}} \quad (3.64)$$

We have $u[\xi] = v^{\frac{1}{m+1}}[\xi]$, so:

For $\alpha > 0$: we obtain the following the solitary solutions

$$u_1[\xi] = \left(\frac{\alpha \left(\frac{n}{m+1} + 1 \right) \operatorname{sech}^2 \left[\frac{1}{2} \sqrt{\alpha} \left(-1 + \frac{n}{m+1} \right) \xi \right]}{2(1-c)} \right)^{\frac{1}{(n-m-1)}} \quad (3.65)$$

$$u_2[\xi] = \left(\frac{\alpha \left(\frac{n}{m+1} + 1 \right) \operatorname{csch}^2 \left[\frac{1}{2} \sqrt{\alpha} \left(-1 + \frac{n}{m+1} \right) \xi \right]}{2(1-c)} \right)^{\frac{1}{(n-m-1)}} \quad (3.66)$$

For $\alpha < 0$: we obtain the following the periodic solutions

$$u_1[\xi] = \left(\frac{\alpha \left(\frac{n}{m+1} + 1 \right) \sec^2 \left[\frac{1}{2} \sqrt{-\alpha} \left(-1 + \frac{n}{m+1} \right) \xi \right]}{2(1-c)} \right)^{\frac{1}{(n-m-1)}} \quad (3.67)$$

$$u_2[\xi] = \left(\frac{\alpha \left(\frac{n}{m+1} + 1 \right) \csc^2 \left[\frac{1}{2} \sqrt{-\alpha} \left(-1 + \frac{n}{m+1} \right) \xi \right]}{2(1-c)} \right)^{\frac{1}{(n-m-1)}} \quad (3.68)$$

Case 2: We have $\xi = x - ct + \xi_0$ and $v = u^n$ Eq. (3.11) becomes the ODE :

$$(-c+1)(v)_\xi - (v)_{\xi\xi\xi} + \alpha \left(v^{\frac{m+1}{n}} \right)_\xi = 0 \quad (3.69)$$

We have the two solutions of the above Eq. (3.69) follow, after some simple algebraic manipulation

For $1 - c > 0$:

$$v_1[\xi] = \left(-\frac{(1-c)\left(\frac{m+1}{n} + 1\right) \operatorname{sech}^2\left[\frac{\sqrt{1-c}}{2}\left(\frac{m+1}{n} - 1\right)\xi\right]}{2\alpha} \right)^{\frac{n}{(m+1-n)}} \quad (3.70)$$

$$v_2[\xi] = \left(\frac{(1-c)\left(\frac{m+1}{n} + 1\right) \operatorname{csch}^2\left[\frac{\sqrt{1-c}}{2}\left(\frac{m+1}{n} - 1\right)\xi\right]}{2\alpha} \right)^{\frac{n}{(m+1-n)}} \quad (3.71)$$

For $1 - c < 0$:

$$v_1[\xi] = \left(-\frac{(1-c)\left(\frac{m+1}{n} + 1\right) \sec^2\left[\frac{\sqrt{-(1-c)}}{2}\left(\frac{m+1}{n} - 1\right)\xi\right]}{2\alpha} \right)^{\frac{n}{(m+1-n)}} \quad (3.72)$$

$$v_2[\xi] = \left(\frac{(1-c)\left(\frac{m+1}{n} + 1\right) \csc^2\left[\frac{\sqrt{-(1-c)}}{2}\left(\frac{m+1}{n} - 1\right)\xi\right]}{2\alpha} \right)^{\frac{n}{(m+1-n)}} \quad (3.73)$$

We have $u[\xi] = v^{\frac{1}{n}}[\xi]$, so:

For $1 - c > 0$: we obtain the following the solitary solutions

$$u_1[\xi] = 2^{\frac{-1}{1+m-n}} \left(\frac{(1-c)\left(\frac{m+1}{n} + 1\right) \operatorname{sech}^2\left[\frac{\sqrt{1-c}}{2}\left(\frac{m+1}{n} - 1\right)\xi\right]}{\alpha} \right)^{\frac{1}{m+1-n}} \quad (3.74)$$

$$u_2[\xi] = 2^{\frac{-1}{1+m-n}} \left(\frac{(1-c)\left(\frac{m+1}{n} + 1\right) \operatorname{csch}^2\left[\frac{\sqrt{1-c}}{2}\left(\frac{m+1}{n} - 1\right)\xi\right]}{\alpha} \right)^{\frac{1}{m+1-n}} \quad (3.75)$$

For $1 - c < 0$: we obtain the following the periodic solutions

$$u_1[\xi] = 2^{\frac{-1}{1+m-n}} \left(\frac{(1-c)\left(\frac{m+1}{n} + 1\right) \sec^2\left[\frac{\sqrt{-(1-c)}}{2}\left(\frac{m+1}{n} - 1\right)\xi\right]}{\alpha} \right)^{\frac{1}{m+1-n}} \quad (3.76)$$

$$u_2[\xi] = 2^{\frac{-1}{1+m-n}} \left(\frac{(1-c)\left(\frac{m+1}{n} + 1\right) \csc^2\left[\frac{\sqrt{-(1-c)}}{2}\left(\frac{m+1}{n} - 1\right)\xi\right]}{\alpha} \right)^{\frac{1}{m+1-n}} \quad (3.77)$$

3.3.4 A generalized form of the BBM equation with negative exponents

Motivated by the rich treasure of the Benjamin–Bona–Mahony equation in science, we will study a generalized form of the BBM equation with negative exponents respectively.

Case 1: We have $\xi = x - ct + \xi_0$ and $v = u^{-n}$ Eq. (3.12) becomes the ODE:

$$(-c + 1)(v)_\xi - (v)_{\xi\xi\xi} + \alpha(v^{-\frac{m+1}{n}})_\xi = 0 \quad (3.78)$$

We obtain two solutions, after some simple algebraic manipulation

For $1 - c > 0$:

$$v_1[\xi] = \left(-\frac{(1-c)(-m-1+n) \operatorname{sech}^2\left[\frac{1}{2}\sqrt{1-c}\left(\frac{-m-1+n}{n}\right)\xi\right]}{2n\alpha} \right)^{\frac{n}{(-m-1+n)}} \quad (3.79)$$

$$v_2[\xi] = \left(\frac{(1-c)(-m-1+n) \operatorname{csch}^2\left[\frac{1}{2}\sqrt{1-c}\left(\frac{-m-1+n}{n}\right)\xi\right]}{2n\alpha} \right)^{\frac{n}{(-m-1+n)}} \quad (3.80)$$

For $1 - c < 0$:

$$v_1[\xi] = \left(-\frac{(1-c)(-m-1+n) \operatorname{sec}^2\left[\frac{1}{2}\sqrt{-(1-c)}\left(\frac{-m-1+n}{n}\right)\xi\right]}{2n\alpha} \right)^{\frac{n}{(-m-1+n)}} \quad (3.81)$$

$$v_2[\xi] = \left(\frac{(1-c)(-m-1+n) \operatorname{csc}^2\left[\frac{1}{2}\sqrt{-(1-c)}\left(\frac{-m-1+n}{n}\right)\xi\right]}{2n\alpha} \right)^{\frac{n}{(-m-1+n)}} \quad (3.82)$$

We have $u[\xi] = v^{\frac{1}{n}}[\xi]$, so :

For $1 - c > 0$: we obtain the following the solitary solutions

$$u_1[\xi] = 2^{\frac{-1}{1+m-n}} \left(\frac{(1-c)(-m-1+n) \operatorname{sech}^2 \left[\frac{1}{2} \sqrt{1-c} \left(\frac{-m-1+n}{n} \right) \xi \right]}{n\alpha} \right)^{\frac{1}{(-m-1+n)}} \quad (3.83)$$

$$u_2[\xi] = 2^{\frac{-1}{1+m-n}} \left(\frac{(1-c)(-m-1+n) \operatorname{csch}^2 \left[\frac{1}{2} \sqrt{1-c} \left(\frac{-m-1+n}{n} \right) \xi \right]}{n\alpha} \right)^{\frac{1}{(-m-1+n)}} \quad (3.84)$$

For $1 - c < 0$: we obtain the following the periodic solutions

$$u_1[\xi] = 2^{\frac{-1}{1+m-n}} \left(\frac{(1-c)(-m-1+n) \sec^2 \left[\frac{1}{2} \sqrt{-(1-c)} \left(\frac{-m-1+n}{n} \right) \xi \right]}{n\alpha} \right)^{\frac{1}{(-m-1+n)}} \quad (3.85)$$

$$u_2[\xi] = 2^{\frac{-1}{1+m-n}} \left(\frac{(1-c)(-m-1+n) \operatorname{csc}^2 \left[\frac{1}{2} \sqrt{-(1-c)} \left(\frac{-m-1+n}{n} \right) \xi \right]}{n\alpha} \right)^{\frac{1}{(-m-1+n)}} \quad (3.86)$$

Graphically, we show in Fig. (3.5), and Fig. (3.6) the formation of periodic solutions $u_1[\xi]$ for $1-c < 0$:

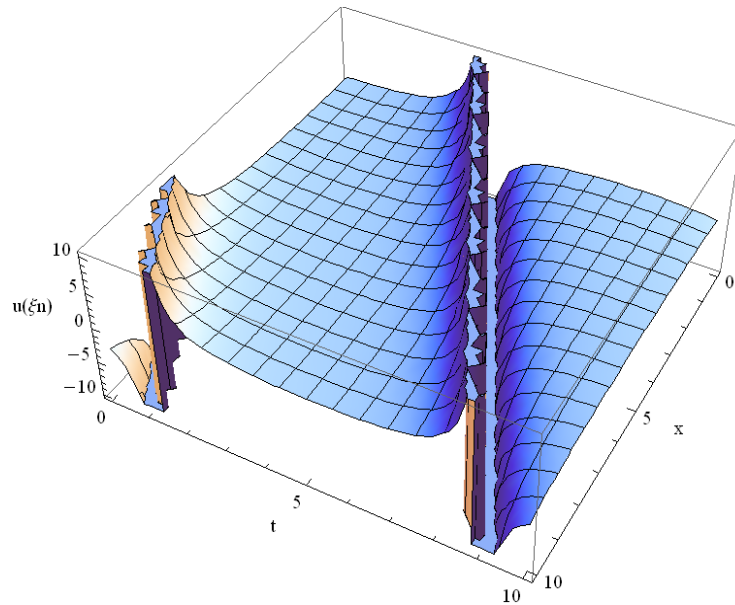
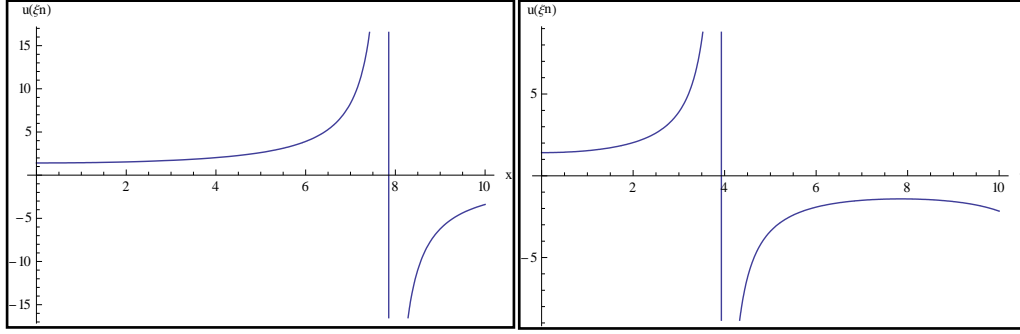

Figure 3.5 Plot 3D representation of Eq. (3.85) and $n = 5, m = 2, \alpha = 1, c = 2$ and $\xi_0 = 0$



for $t = 0$

for $x = 0$

Figure 3.6 Plot 2D representation of Eq. (3.85) and $n = 5, m = 2, \alpha = 1, c = 2$ and $\xi_0 = 0$

Case 2: If $\xi = x - ct + \xi_0$ and $v = u^{m+1}$ Eq. (3.12) becomes the ODE:

$$(-c + 1)(v^{-\frac{n}{m+1}})_\xi - (v^{-\frac{n}{m+1}})_{\xi\xi\xi} + \alpha(v)_\xi = 0 \quad (3.87)$$

The two solutions of the above system Eq. (3.87) follow:

For $\alpha > 0$:

$$v_1[\xi] = \left(\frac{-\alpha \left(-\frac{n}{m+1} + 1 \right) \operatorname{sech}^2 \left[\frac{1}{2} \sqrt{\alpha} \left(-1 - \frac{n}{m+1} \right) \xi \right]}{2(1-c)} \right)^{\frac{-m-1}{(n+m+1)}} \quad (3.88)$$

$$v_2[\xi] = \left(\frac{\alpha \left(-\frac{n}{m+1} + 1 \right) \operatorname{csch}^2 \left[\frac{1}{2} \sqrt{\alpha} \left(-1 - \frac{n}{m+1} \right) \xi \right]}{2(1-c)} \right)^{\frac{-m-1}{(n+m+1)}} \quad (3.89)$$

For $\alpha < 0$:

$$v_1[\xi] = \left(\frac{-\alpha\left(-\frac{n}{m+1} + 1\right) \sec^2\left[\frac{1}{2}\sqrt{-\alpha}\left(-1 - \frac{n}{m+1}\right)\xi\right]}{2(1-c)} \right)^{\frac{-m-1}{(n+m+1)}} \quad (3.90)$$

$$v_2[\xi] = \left(\frac{\alpha\left(-\frac{n}{m+1} + 1\right) \csc^2\left[\frac{1}{2}\sqrt{-\alpha}\left(-1 - \frac{n}{m+1}\right)\xi\right]}{2(1-c)} \right)^{\frac{-m-1}{(n+m+1)}} \quad (3.91)$$

We have $u[\xi] = v^{\frac{1}{m+1}}[\xi]$, so:

For $\alpha > 0$: we obtain the following the solitary solutions

$$u_1[\xi] = \left(-\frac{\alpha\left(-\frac{n}{m+1} + 1\right) \operatorname{sech}^2\left[\frac{1}{2}\sqrt{\alpha}\left(-1 - \frac{n}{m+1}\right)\xi\right]}{2(1-c)} \right)^{\frac{-1}{(n+m+1)}} \quad (3.92)$$

$$u_2[\xi] = \left(\frac{\alpha\left(-\frac{n}{m+1} + 1\right) \operatorname{csch}^2\left[\frac{1}{2}\sqrt{\alpha}\left(-1 - \frac{n}{m+1}\right)\xi\right]}{2(1-c)} \right)^{\frac{-1}{(n+m+1)}} \quad (3.93)$$

For $\alpha < 0$: we obtain the following the periodic solutions

$$u_1[\xi] = \left(-\frac{\alpha\left(-\frac{n}{m+1} + 1\right) \sec^2\left[\frac{1}{2}\sqrt{-\alpha}\left(-1 - \frac{n}{m+1}\right)\xi\right]}{2(1-c)} \right)^{\frac{-1}{(n+m+1)}} \quad (3.94)$$

$$u_2[\xi] = \left(\frac{\alpha \left(-\frac{n}{m+1} + 1 \right) \csc^2 \left[\frac{1}{2} \sqrt{-\alpha} \left(-1 - \frac{n}{m+1} \right) \xi \right]}{2(1-c)} \right)^{\frac{-1}{(n+m+1)}} \quad (3.95)$$

3.4 Discussions

The exact solutions of BBM equations obtained by Wazwaz in the literature [1, 6, 20, 22, 23, 24] found that some of their exact solutions are uniform with what is found here if the parameters and coefficients are appropriately chosen.

We also notice that the work of [21] is of the same types to the nonlinear equations of BBM that we studied where it gave three kinds of exact traveling wave solutions; one periodic solution and two solitary wave solutions by using the unified algebraic method with symbolic computation in each BBM equation with negative exponents numbers (3.10) and (3.12). These types of traveling wave solutions are also obtained in our method, but the difference is in the number of types, where we find four types of exact traveling wave solutions; two periodic solutions and two solitary wave solutions that prove the effectiveness and strength of the function variable method.

There is another difference about solutions in equations (3.09), (3.11), we have periodic solutions and solitary wave solutions but they obtained compacton solutions and solitary patterns solutions in [21].

3.5 Conclusion

In this work, we have introduced the new functional variable method to find the exact structures of solutions to a class of nonlinear wave equations with constant coefficients (BBM equation) where we have constructed a series of travelling wave solutions for solitary wave and periodic wave of the one-dimensional generalized BBM equation of any order with positive and negative exponents which proves the effectiveness and success of this method.

A wide variety of modern examples of applications from nonlinear areas of plasma physics, fluid dynamics, nonlinear optics, and gas dynamics can be carefully handled by this method. This finding suggests that the formulation of the functional variable method presented in this work can be readily extended to complex nonlinear evolution systems. This matter is in progress.

References

- [1] Wazwaz A M. Exact solutions with compact and non compact structures for the one-dimensional generalized Benjamin–Bona–Mahony equation. *Commun Nonlinear Sci Numer Simul* 2005; 10: 855–67.
- [2] Wazwaz A-M. A computational approach to soliton solutions of the Kadomtsev–Petviashvili equation. *Appl Math Comput* 2001;123(2):205–17
- [3] Wazwaz A-M. An analytic study of compacton structures in a class of nonlinear dispersive equations. *Math Comput Simul* 2003; 63(1):35–44.
- [4] Wazwaz A-M. The tanh method for travelling wave solutions of nonlinear equations. *Appl Math Comput* 2004; 154 (3): 713–23.
- [5] Wazwaz A-M. *Partial Differential Equations: Methods and Applications*. The Netherlands: Balkema Publishers; 2002.
- [6] Abdul-Majid Wazwaz, Exact solutions of compact and non compact structures for the KP–BBM equation, *Applied Mathematics and Computation* 169 (2005) 700–712
- [7] Malfliet W, Hereman W. The tanh method: II. Perturbation technique for conservative systems. *Phys Scr* 1996;54:563–75.
- [8] M. Boiti, J. Leon. Scattering of localized soliton in the plane. *Physics Letters A*, 1988, 132:432–439
- [9] J. Fang, W. Yao. Adomian's decomposition method for the solution of generalized duffing equations. in: *In Proceedings of the International Workshop on Mathematics Mechanization, Beijing, China, 1992*

- [10] B. Fornberg, G. Whitham. A numerical and theoretical study of certain nonlinear wave phenomena. *Philosophical Transactions of the Royal Society A*, 1978, 289:373–404.
- [11] C. Gardner, J. Green, et al. Method for solving the KdV equation. *Physical Review Letters*, 1967, 19:1095–1097
- [12] R. Hirota. Exact solution of KDV equation for multiple collisions of solitons. *Physical Review Letters*, 1971, 27: 1192–1194.
- [13] L. Iskandar. New numerical solution of the Korteweg-de Vries equation. *Applied Numerical Analysis and Computational Mathematics*, 1989, 5:215–221
- [14] T. Ozis, A. Yildirim, Reliable analysis for obtaining exact soliton solutions of nonlinear Schrodinger (NLS) equation. *Chaos, Solitons and Fractals*, 2008, 38:209–212.
- [15] A. Scott, E. Chu, D. Mc Laughlin. The soliton: A new concept in applied science. in: *In Proceedings of IEEE*, 1973, vol. 61, 1443–1483
- [16] L. Xu, J. Zhang. Exact solutions to two higher order nonlinear Schroedinger equations. *Chaos, Solitons and Fractals*, 2007, 31:937–942
- [17] V. Zakharov, A. Shabat. Exact theory of two-dimensional self focusing and one-dimensional waves in non-linear media. *Soviet Physics-JETP*, 1972, 34:62–69.
- [18] A. Zerarka and S. Ouamane, *World Journal of Modelling and Simulation*, 2010, Vol. 6 No. 2, pp. 150-160
- [19] A. Zerarka, S. Ouamane and A. Attaf, *Waves in Random and Complex Media*, 2011, vol 21, No1, 44-56.

- [20] Abdul-Majid Wazwaz, The extended tanh method for new compact and non compact solutions for the KP–BBM and the ZK–BBM equations, *Chaos, Solitons and Fractals* 2008,vol 38, 1505–1516.
- [21] Yaning Tang, Wei Xu, Liang Gao, Jianwei Shen, An algebraic method with computerized symbolic Computation for the one-dimension al generalized BBM equation of any order, *Chaos, Solitons and Fractals* ,2007,vol 32, 1846–1852.
- [22] Abdul-Majid Wazwaz, Compact and noncompact physical structures for the ZK–BBM equation, *Applied Mathematics and Computation* ,2005,vol 169, 713–725.
- [23] Abdul-Majid Wazwaz, The extended tanh method for new compact and noncompact solutions for the KP–BBM and the ZK–BBM equations, *Chaos, Solitons and Fractals* 2008,vol 38, 1505–1516.
- [24] Abdul-Majid Wazwaz, M.A. Helal, Nonlinear variants of the BBM equation with compact and noncompact physical structures, *Chaos, Solitons and Fractals*, 2005,vol 26, 767–776.

Chapter 4

Exact solutions for the KdV–mKdV equation with time–dependent coefficients using the modified functional variable method

4.1 Introduction

There are several forms of nonlinear partial differential equations have been presented in the past decades to investigate new exact solutions. Several methods [1–12] have been proposed to handle a wide variety of linear and non-linear wave equations. As is well known, the descriptions of these nonlinear model equations were appeared to supply different structures to the solutions. Among these are the auto–Backlund transformation, inverse scattering method, Hirota method, Miura's transformation.

The availability of symbolic computation packages can be facilitate many direct approaches to establish solutions to non-linear wave equations [13–17]. Various extension forms of the sine–cosine and tanh methods proposed by Malfliet and Wazwaz have been applied to solve a large class of nonlinear equations [18–19]. More importantly, another mathematical treatment is established and used in the analysis of these nonlinear problems, such as Jacobian elliptic function expansion method, the variational iteration method, pseudo spectral method, and many others powerful methods [20–21].

One of the major goals of the present chapter is to provide an efficient approach based on the functional variable method to examine new developments in a direct manner without requiring any additional condition on the investigation of exact solutions for the combined KdV–mKdV equation. Abundant exact solutions are obtained together with the aid of symbol calculation software, such as Mathematica.

4.2 Description of the method fvm

To clarify the basic idea of fvm proposed in our paper [22], we present the governing equation written in several independent variables as

$$R(u, u_t, u_x, u_y, u_z, u_{xy}, u_{yz}, u_{xz}, u_{xx}, \dots) = 0, \quad (2.1)$$

where the subscripts denote differentiation, while $u(t, x, y, z, \dots)$ is an unknown function to be determined. Equation (4.1) is a nonlinear partial differential equation that is not integrable, in general. Sometime it is difficult to find a complete set of solutions. If the solutions exist, there are many methods which can be used to handle these nonlinear equations.

The following transformation is used for the new wave variable as

$$\xi = \sum_{i=0}^p \alpha_i \chi_i + \delta, \quad (2.2)$$

χ_i are distinct variables, and when $p = 1$, $\xi = \alpha_0 \chi_0 + \alpha_1 \chi_1 + \delta$, and if the quantities α_0, α_1 are constants, then, they are called the wave pulsation ω and the wave number k respectively if χ_0, χ_1 are the variables t and x respectively. We give the traveling wave reduction transformation for Eq. (4.1) as

$$u(\chi_0, \chi_1, \dots) = U(\xi), \quad (2.3)$$

and the chain rule

$$\frac{\partial}{\partial \chi_i} (\cdot) = \alpha_i \frac{d}{d\xi} (\cdot), \quad \frac{\partial^2}{\partial \chi_i \partial \chi_j} (\cdot) = \alpha_i \alpha_j \frac{d^2}{d\xi^2} (\cdot), \dots \quad (2.4)$$

Upon using (4.3) and (4.4), the nonlinear problem (4.1) with suitably chosen variables becomes an ordinary differential equation (ODE) like

$$Q(U, U_\xi, U_{\xi\xi}, U_{\xi\xi\xi}, U_{\xi\xi\xi\xi}, \dots) = 0. \quad (2.5)$$

A transformation of functions as variables can sometimes be found that transforms a nonlinear equation into a linear equation, or some other nonlinear equation easily integrable. Thus, if the unknown function U is treated as a functional variable in the form

$$U_\xi = F(U), \quad (2.6)$$

then, the solution can be found by the relation

$$\int \frac{dU}{F(U)} = \xi + a_0, \quad (2.7)$$

here a_0 is a constant of integration which is set equal to zero for convenience. Some successive differentiations of U in terms of F are given as

$$\begin{aligned}
U_{\xi\xi} &= \frac{1}{2}(F^2)', \\
U_{\xi\xi\xi} &= \frac{1}{2}(F^2)''\sqrt{F^2}, \\
U_{\xi\xi\xi\xi} &= \frac{1}{2}[(F^2)'''F^2 + (F^2)''(F^2)'], \\
&\vdots,
\end{aligned} \tag{2.8}$$

where " ' " stands for $\frac{d}{dU}$. The ordinary differential equation (4.5) can be reduced in terms of U , F and its derivatives upon using the expression of (4.8) into (4.5) give

$$R(U, F, F', F'', F''', F^{(4)}, \dots) = 0. \tag{2.9}$$

The key idea of this particular form (4.9) is of special interest because it admits analytical solutions for a large class of nonlinear wave type equations. After integration, the Eq. (4.9) provides the expression of F , and this in turn together with (4.6) give the relevant solutions to the original problem.

4.3 KdV–mKdV solutions

Let us consider the KdV–mKdV equation [23–25] is written as

$$u_t - 6h_0(t)uu_x - 6h_1(t)u^2u_x + h_2(t)u_{xxx} - h_3(t)u_x + h_4(t)(Au + xu_x) = 0. \tag{2.10}$$

This equation arises in many physical problems including the motions of waves in nonlinear optics, plasma or fluids, water waves, ion–acoustic waves in a collisionless plasma, where $h_i, i = 0, 1, 2, 3, 4$, are arbitrary smooth model functions that symbolize the coefficients of the time variable t and the subscripts denote the partial differentiations with respect to the corresponding variable. The first element u_t designates the evolution term which governs how the wave evolves

with respect to time, while the second one shows the term of dispersion. We first combine the independent variables, into a wave variable using ξ as

$$\xi = \alpha(t)x + \beta(t), \quad (2.11)$$

where α and β are time-dependent functions, and we write the travelling wave solutions of Eq. (4.10) with (4.11) as $u(x,t) = U(t,\xi)$. By using the chain rule (4.4), the differential equation (4.10) can be transformed as:

$$U_t + (\alpha_t x + \beta_t)U' - 6\alpha h_0(t)UU' - 6\alpha h_1(t)U^2U' + \alpha^3 h_2(t)U''' - \alpha h_3(t)U' + h_4(t)(AU + \alpha xU') = 0, \quad (2.12)$$

where the primes denote the derivatives with respect to the argument ξ , and it is known that many nonlinear models with linear dispersion coefficient $h_2(t)$ and convection coefficient $h_0(t)$ generate quite stable structures such as the solitons and kink solutions.

4.4 Partial structures

In order to prepare the complete solution for Eq. (4.10), we begin with the special case when $h_4 = 0$ and α, β and h_i , $i = 0, 1, 2, 3$ are constant functions. Thus, Equation (4.10) is then integrated as long as all terms contain derivatives where integration constants are considered zeros, and it looks like following:

$$-\alpha h_3(t)U - 3\alpha h_0(t)U^2 - 2\alpha h_1(t)U^3 + \alpha^3 h_2(t)U'' = 0, \quad (2.13)$$

from Eq.(4.13) and the method fvm, we obtain

$$F(U) = U' = \sqrt{aU^2 + bU^3 + cU^4}, \quad (2.14)$$

where

$$\begin{aligned}
 a &= \frac{h_3(t)}{\alpha^2 h_2(t)}, \\
 b &= \frac{2h_0(t)}{\alpha^2 h_2(t)}, \\
 c &= \frac{h_1(t)}{\alpha^2 h_2(t)}.
 \end{aligned} \tag{2.15}$$

From (4.14), we obtain the desired solution as [5, 26]

$$U(\xi) = \begin{cases} \frac{2a \operatorname{sech}(\sqrt{a}\xi)}{\varepsilon \sqrt{b^2 - 4ac} - b \operatorname{sech}(\sqrt{a}\xi)}, & a > 0, b^2 - 4ac > 0, \\ \frac{2a \operatorname{csch}(\sqrt{a}\xi)}{\varepsilon \sqrt{4ac - b^2} - b \operatorname{csch}(\sqrt{a}\xi)}, & a > 0, b^2 - 4ac < 0, \\ \frac{-ab \operatorname{sech}^2\left(\frac{\sqrt{a}}{2}\xi\right)}{b^2 - ac \left(1 + \varepsilon \tanh\left(\frac{\sqrt{a}}{2}\xi\right)\right)^2}, & a > 0, \\ -\frac{a}{b} \left[1 + \varepsilon \tanh\left(\frac{\sqrt{a}}{2}\xi\right)\right], & a > 0, b^2 = 4ac, \\ \varepsilon = \pm 1. \end{cases} \tag{2.16}$$

4.5 Full structures

Now we reveal the main features of solutions by working directly from (4.14) and (4.16). Let us take a closer look at the equation in presence of the term h_4 and α, β and h_i , $i = 0, 1, 2, 3, 4$ are time-dependent functions. According to the previous situation, we expand the solution of Eq. (4.12) in the form:

$$U(t, \xi) = \sum_{k=0}^M q_k \Phi^k(\xi), \tag{2.17}$$

where Φ satisfies Eq. (4.14) as

$$\Phi' = \sqrt{\lambda\Phi^2 + \mu\Phi^3 + \nu\Phi^4}, \quad (2.18)$$

and the possible structures are known from (4.16), and λ , μ and ν are free parameters and M is an undetermined integer and q_k are coefficients to be determined later. One of the most useful techniques for obtaining the parameter M in (4.17) is the homogeneous balance method. Substituting from (4.17) into Eq. (4.12) and by making balance between the linear term (cubic dispersion) U''' and the nonlinear term (cubic nonlinearity) U^2U' to determine the value of M , and by simple calculation we have got that $M + 1 = 3M - 1$, this in turn gives $M = 1$, and the solution (4.17) takes the form

$$U(t, \xi) = q_0 + q_1\Phi(\xi). \quad (2.19)$$

Now, we substitute (4.19) into (4.12) along with (4.18) and set each coefficient of $\Phi^k (\Phi')^l$ and $x\Phi^l$ ($k = 0, 1, 2$ and $l = 0, 1$) to zero to obtain a set of algebraic equations for q_0 , q_1 , α , and β as,

$$\begin{aligned} \frac{dq_0}{dt} + Ah_4q_0 &= 0, \quad (a) \\ \frac{dq_1}{dt} + Ah_4q_1 &= 0, \quad (b) \\ \frac{d\alpha}{dt} + h_4\alpha &= 0, \quad (c) \\ \frac{d\beta}{dt} - 6h_0q_0\alpha - 6h_1q_0^2\alpha + h_2\alpha^3\lambda - h_3\alpha &= 0, \quad (d) \\ h_2\alpha^2\mu - 4h_1q_0q_1 - 2h_0q_1 &= 0, \quad (e) \\ h_2\alpha^2\nu - h_1q_1^2 &= 0. \quad (f) \end{aligned} \quad (2.20)$$

Solving the system of algebraic equations, we would end up with the explicit pulse parameters for q_0 , q_1 , α and β , we obtain

$$\begin{aligned}
 q_0(t) &= q_{00} e^{-A \int h_4 dt}, \\
 q_1(t) &= q_{10} e^{-A \int h_4 dt}, \\
 \alpha(t) &= \alpha_0 e^{-\int h_4 dt}, \\
 \beta(t) &= \int (6h_0 q_0 \alpha + 6h_1 q_0^2 \alpha - h_2 \alpha^3 \lambda + h_3 \alpha) dt + \beta_0,
 \end{aligned} \tag{2.21}$$

where q_{00} , q_{10} , α_0 and β_0 are the integration constants and are identified from initial data of the pulse. Notice that (4.20e) and (4.20f) serve as constraint relations between the coefficient functions and the pulse parameters.

From (4.20e) and (4.20f), one may find that

$$q_{00} - \frac{\mu}{4\nu} q_{10} = -\frac{h_0}{2h_1} e^{A \int h_4 dt}, \tag{2.22}$$

And

$$\frac{\alpha_0}{q_{10}} = \sqrt{\frac{h_1}{h_2 \nu}} e^{(1-A) \int h_4 dt}, \quad h_1 h_2 \nu > 0, \tag{2.23}$$

which indicate that (4.22) and (4.23) must be satisfied to assure the existence and the formation process of soliton structures. Taking account of these data, we attain the exact solutions for Equation (4.12) as following

$$\begin{aligned}
u_1(x,t) &= e^{-A \int h_4 dt} \left(q_{00} + q_{10} \frac{2\lambda \operatorname{sech}(\sqrt{\lambda} \xi)}{\varepsilon \sqrt{\mu^2 - 4\lambda\nu} - \mu \operatorname{sech}(\sqrt{\lambda} \xi)} \right), \quad (a) \\
&\lambda > 0, \quad \mu^2 - 4\lambda\nu > 0, \\
u_2(x,t) &= e^{-A \int h_4 dt} \left(q_{00} + q_{10} \frac{2\lambda \operatorname{csch}(\sqrt{\lambda} \xi)}{\varepsilon \sqrt{4\lambda\nu - \mu^2} - \mu \operatorname{csch}(\sqrt{\lambda} \xi)} \right), \quad (b) \\
&\lambda > 0, \quad \mu^2 - 4\lambda\nu < 0, \\
u_3(x,t) &= e^{-A \int h_4 dt} \left(q_{00} + q_{10} \frac{-\lambda\mu \operatorname{sech}^2\left(\frac{\sqrt{\lambda}}{2} \xi\right)}{\mu^2 - \lambda\nu \left(1 + \varepsilon \tanh\left(\frac{\sqrt{\lambda}}{2} \xi\right)\right)^2} \right), \quad (c) \\
&\lambda > 0, \\
u_4(x,t) &= e^{-A \int h_4 dt} \left(q_{00} - q_{10} \frac{\lambda}{\mu} \left[1 + \varepsilon \tanh\left(\frac{\sqrt{\lambda}}{2} \xi\right) \right] \right), \quad (d) \\
&\lambda > 0, \quad \mu^2 = 4\lambda\nu,
\end{aligned} \tag{2.24}$$

where $(u_i(x,t) = U_i(t, \xi))$, $i = 1, 2, 3, 4$, $\xi = \alpha(t)x + \beta(t)$ and $\varepsilon = \pm 1$.

We note that, Equation (4.18) admits several other types of solutions; it is easy to see that we can include more solutions as listed in [5], we omit these results here. The propagation velocity of the soliton pulse is related to parameters describing the process and is expressed by the relation $v(t) = \frac{d\beta(t)/\alpha(t)}{dt}$, and the inverse widths are given by $\alpha(t)\sqrt{\lambda}$ and $\alpha(t)\frac{\sqrt{\lambda}}{2}$, which exist provided $\lambda > 0$ for the wave solutions (4.24) respectively. All the solutions found have been verified through substitution with the help of Mathematica software. However, to our best knowledge, all solutions obtained are completely new except the solution 3 is just the result found by Triki et al. [23] with a different route using directly the ansatz method.

A qualitative plot of the solution (24a), $u_1(x, t) = U_1(\xi)$ is presented in Figure 4.1, and the Figure 4.2 shows the physical wave (24d), $u_4(x, t) = U_4(\xi)$. It is apparent that the amplitude contributes to the formation of solitons mainly through the model function $h_4(t)$ (for full structures). Consequently, in the absence of the coefficient function $h_4(t)$ or the parameter A , the partial and full structures become substantially equivalent versions.

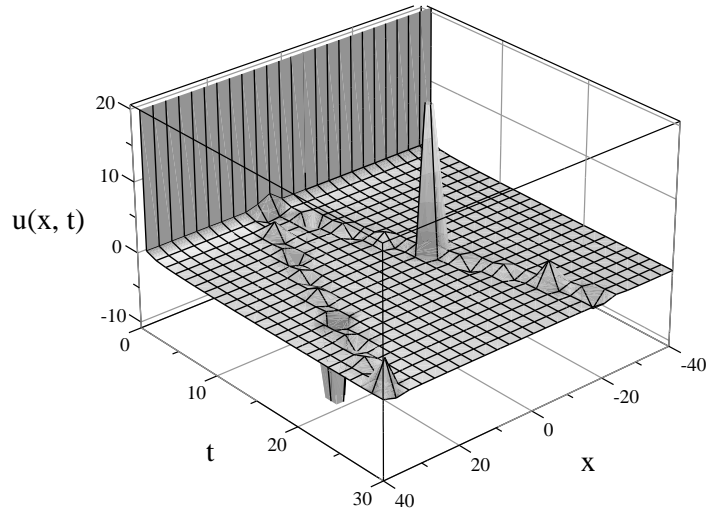

Figure 4.1 The graph shows the wave solution of $u_1(x, t) = U_1(\xi)$ in (4.24a). The curve was performed with the parameters $A = 1$, $\mu = 4$, $\lambda = 1$, $\nu = 3$, $\varepsilon = 1$, $q_{00} = \frac{4}{3}$, $q_{10} = 1$, $\alpha_0 = \sqrt{\frac{2}{3}}$, $\beta_0 = 0$, $h_0 = 4$, $h_1 = -2t$, $h_2 = -t$, $h_3 = \frac{2}{t}$, $h_4 = t^{-1}$

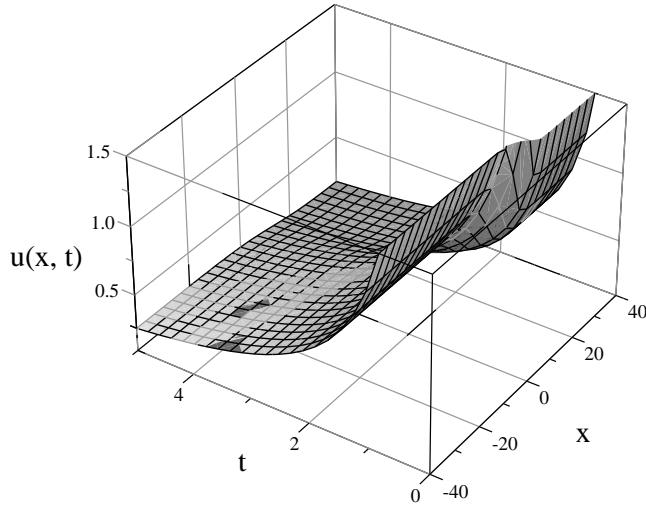

Figure 4.2 The evolution of the wave solution $u_4(x, t) = U_4(\xi)$ given by Eq. (4.24d), input parameters: $A = 1$, $\mu = 4$, $\lambda = 1$, $\nu = 4$, $\varepsilon = 1$, $q_{00} = \frac{4}{3}$, $q_{10} = 1$, $\alpha_0 = \sqrt{\frac{1}{2}}$, $\beta_0 = 0$, $h_0 = 4$, $h_1 = -2t$, $h_2 = -t$, $h_3 = \frac{2}{t}$, $h_4 = t^{-1}$.

4.6 Conclusion

In this work, we applied a new analytical technique namely, the functional variable method (fvm) to establish some new exact analytic wave structures to the KdV-mKdV equation with time-dependent coefficients. On one side, for the first case study, we obtained the limited solutions using the partial structures for the function $h_4 = 0$. On the other side, for the second case study, we introduced the results obtained for the partial structures to solve the KdV-mKdV nonlinear differential equation for the full structures in the presence of the function $h_4 \neq 0$. Four variants of complete travelling wave solutions are obtained. The present method provides a reliable technique that requires less work if compared with the difficulties arising from computational aspect. The main advantage of this method is the flexibility to give exact solutions to nonlinear PDEs without any need for perturbation techniques, and does not require linearizing or discrediting. All calculations are performed using Mathematica.

We may conclude that, this method can be easily extended to find the solution of some high-dimensional nonlinear problems. These points will be investigated in a future research.

References

- [1] D.-S. Wang and H. Li. Symbolic computation and non-travelling wave solutions of $(2+1)$ - dimensional nonlinear evolution equations. *Chaos, Solitons and Fractals*, 2008, vol 38, 383 -- 390.
- [2] D. J. Korteweg and G. de Vries, On the change of the form of long waves advancing in a rectangular canal and on a new type of long stationary waves. *Philos. Mag*, 1895, 39.
- [3] N. C. Freeman and R. S. Johnson, Shallow water waves on shear flows, *J. of Fluid. Mech*, 1970, vol **42**, 401-409.
- [4] A. Zerarka, Solution of Korteweg-de Vries equation by decomposition method. *Internat. Cong. on Math. Appl. and Ingeen. Sc, Casa* (1996).
- [5] Sirendaoreji. Auxiliary equation method and new solutions of Klein-Gordon equations. *Chaos, Solitons & Fractals* 2007, vol 31, 943-50.
- [6] Sirendaoreji. New exact travelling wave solutions for the Kawahara and modified Kawahara equations. *Chaos, Solitons & Fractals* 2004, vol 19, 147 --50.
- [7] Wazwaz AM. Analytic study on nonlinear variants of the RLW and the PHI-four equation. *Communications in Nonlinear Science and Numerical Simulation*, 2007, vol 12, 314-327
- [8] Dye JM, Parker A. An inverse scattering scheme for the regularized long-wave equation. *J Math Phys* 2000, vol 41(5), 2889-904.
- [9] Benjamin RT, Bona JL, Mahony JJ. Model equations for long waves in nonlinear dispersive systems. *Philos Trans Roy Soc London* 1972, vol 272, 47-78.
- [10] Khelil N., Bensalah N., Saidi H., Zerarka A. Artificial perturbation for solving the Korteweg-de Vries equation. *J Zhejiang Univ SCIENCE A*, 2006, vol

7(12), 2079–2082.

- [11] Zerarka and V. G. Foester. Separation method for solving the generalized Korteweg –de Vries equation. *Comm. Nonl. Sc. Num. Sim*, 2005, Vol 10, 217–225.
- [12] Wazwaz AM. New solitary–wave special solutions with compact support for the nonlinear dispersive K (m, n) equations. *Chaos, Solitons & Fractals*, 2002, vol 13(2), 321–30.
- [13] R. Hirota, Exact solution of KdV equation for multiple collisions of solitons, *Phys. Rev. Lett*, 1971, vol **27**, 1192–1194.
- [14] L. Iskandar, New numerical solution of the Korteweg–de Vries equation, *Appl. Num. Math*, 1989, vol **5**, 215–221 .
- [15] Xu LP, Zhang JL. Exact solutions to two higher order nonlinear Schrödinger equations. *Chaos, Solitons & Fractals*, 2007, vol 31, 937–42.
- [16] F. Jinquing and Y. Wei–Guang, Adomian's decomposition method for the solution of generalized Duffing equations, In *Proc, Internat. Workshop on Mathematics Mechanization, Blijing China, (1992)*.
- [17] Zhou Yubin, Wang Mingliang, Wang Yueming. Periodic wave solutions to a coupled KdV equations with variable coefficients. *Phys Lett A* , 2003, vol 308, 3136.
- [18] Malfliet W. Solitary wave solutions of nonlinear wave equations. *Am J Phys* 1992, vol 60(7), 650–4.
- [19] Fan Engui, Zhang Jian. Applications of the Jacobi elliptic function method to special–type nonlinear equations. *Phys Lett A*, 2002, vol 305(6), 383–92.
- [20] E. Yomba. The extended F–expansion Method and its Application for Solving the Nonlinear Wave, CKGZ, GDS, DS and GZ Equations. *Phys Lett A*. 2005, vol 340, 149–160.
- [21] J. B. Liu and K. Q. Yang. The Extended F–expansion Method and Exact

Solutions of Nonlinear PDEs. Chaos, Solitons and Fractals. 2004, vol 22, 111–121.

- [22] A. Zerarka, S. Ouamane, A. Attaf. Construction of exact solutions to a family of wave equations by the functional variable method. Waves in Random and Complex Media, 2011, Vol 21, No 1, 44–56
- [23] H. Triki, Thiab R. Taha, A.M. Wazwaz. Solitary wave solutions for a generalized KdV--mKdV equation with variable coefficients. Mathematics and Computers in Simulation, 2010, vol 80, 1867–1873
- [24] X. Li, M. Wang, A sub-ODE method for finding exact solutions of a generalized KdV--mKdV equation with high-order nonlinear terms, Phys. Lett A, 2007, vol 361, 115--118.
- [25] A.M.Wazwaz, Analytic study for fifth-order KdV-type equations with arbitrary power nonlinearities, Commun. Nonlinear Sci. Numer. Simul, 2007, vol 12, 904–909.
- [26] Yomba Emmanuel. Construction of new soliton-like solutions for the (2+1) dimensional Kadomtsev--Petviashvili equation. Chaos, Solitons & Fractals, 2004 Vol 22(2), 321--325

General conclusion

The goal in our work is to determine the behaviour of wave solutions by solving nonlinear equations and through two phases:

In the first step we studied the nonlinear lattice equation by applied two types of functions are used to find the exact solutions namely: the coth-function and the coth-csch function methods and the result is eight variants of new exact travelling wave solutions that are obtained, where we note that the system provide us the symmetrically bell solutions and symmetrically kink-shaped soliton solutions and symmetrically kink-shaped solitary solution. In the context of solving the lattice equation we have obtained many types of fractional solutions of the nonlinear lattice equation by using fractional transformations method; the five cases are used to find the exact solutions, these solutions include the symmetrical rational solutions, the symmetrical periodic wave solutions, the symmetrical solitary wave solutions, and the symmetrical Jacobi elliptic function solutions.

We investigated by using these modern methods the results as follows:

- To solve the non-linear lattice equation and we get the series variety of solutions.

- The successful application of our methods for solving the nonlinear lattice equations

- Simplification of analytical processes by using the homogeneous balance principle.

In the second step we applied the functional variable (implicit) method on the set of nonlinear equations of BBM with constant coefficients and the generalized equation of KdV-mKdV with variable coefficients, where we have constructed a series of travelling wave solutions for solitary wave and periodic wave of the one-dimensional generalized equation of BBM for any order with positive and negative exponents.

For establishing some new exact analytic wave structures we applied the functional variable method on the KdV-mKdV equation with time-dependent coefficients. Four variants of complete travelling soliton wave solutions are obtained.

We investigated by applying the functional variable (implicit and modified) method to obtain a series of travelling wave solutions without any need for perturbation techniques and do not require linearizing or discrediting.

Perspectives:

- Using the coth-function and the coth-csch function methods and fractional transformation method to solve some nonlinear wave equations.
- The development of analytical methods of using the homogeneous balance principle.
- The functional variable (implicit and modified) method can be expanded to a wide variety and more complex of nonlinear equations for example the coupled systems.
- The functional variable (implicit and modified) method can be developed and applying it to nonlinear differential systems.

List of Communications and Publications

National Communications

1. W. Djoudi, A. Zerarka. The construction of exact solutions for the nonlinear lattice equation via coth and csch functions method. **The 1st National Seminar on Applied and Theoretical Physics. University of Tebessa, 2014**
2. W. Djoudi, A. Zerarka. Exactly Fractional Travelling Wave Solutions Of Nonlinear Equation Via Some Fractional Transformations. **International Conference Optics and Photonics, Algeria (OPAL) USTHB, 2015.**

International Communications

1. W. Djoudi, A. Zerarka. The construction of exact solutions for the nonlinear lattice equation via coth and csch functions method. **International Conference on Nonlinear Mathematical Physics. Istanbul, Turkey, 16-17, 2015, INTERNATIONAL SCIENTIFIC RESEARCH AND EXPERIMENTAL DEVELOPMENT.**
<http://www.waset.org>
2. W. Djoudi, A. Zerarka. Exact solutions of the nonlinear lattice equation using the ansatz method. **International Conference on Modelling, Simulation and Applied Mathematics (MSAM2015). August 23-24, 2015, Phuket, Thailand**
<http://www.msam2015.org>
3. W. Djoudi, A. Zerarka. Symbolic Computational of Nonlinear Wave Equation via the Functional Variable Method. **International Conference on Nonlinear Mathematical Physics. Istanbul, Turkey, 16-17, 2015. INTERNATIONAL SCIENTIFIC RESEARCH AND EXPERIMENTAL DEVELOPMENT.** <http://www.waset.org>
4. W. Djoudi, A. Zerarka. Exactly Fractional Travelling Wave Solutions Of Nonlinear Equation Via Some Fractional Transformations. **International Conference on Nonlinear Mathematical Physics. Istanbul, Turkey, 16-17, 2015. INTERNATIONAL SCIENTIFIC RESEARCH AND EXPERIMENTAL DEVELOPMENT.**
<http://www.waset.org>

International Publications

1. A. Zerarka, W. Djoudi. Construction of some new exact structures for the nonlinear lattice equation. **International Journal of Physical Sciences (2014)**. <http://www.academicjournals.org/IJPS> , Chemical Abstracts, Google Scholar, Scientific Information Database and more.
2. DJOUDI W., DEBOWSKY G. and ZERARKA A. New Exact Structures for the Nonlinear Lattice Equation by the Auxilliary Fractional Shape. JOURNAL OF PARTIAL DIFFERENTIAL EQUATIONS, **J. Part. Diff. Eq., Vol. 29, No. 3, (2016) pp. 195-203**. <http://www.global-sci.org/jpde/>, **Mathematical Reviews® (MathSciNet®)**
3. W. Djoudi, A. Zerarka. Exact structures for the KdV–mKdV equation with variable coefficients via the functional variable method. **Optik 127 (16 May 2016) 9621–9626**. **Science direct**. <https://www.journals.elsevier.com/optik/> , Chemical Abstracts, Physics Abstracts, Science Citation Index,...
4. W. Djoudi, A. Zerarka. Exact solutions for the KdV–mKdV equation with time-dependent coefficients using the modified functional variable method. **Cogent Mathematics (15 June 2016), 3: 1218405**. **Taylor & Francis Group**. <https://www.cogentia.com/journal/mathematics>, (<http://www.tandfonline.com/toc/oama20/current>) **Web of Science(ESCI)**



République Algérienne Démocratique et Populaire
Ministère de l'Enseignement Supérieur et de la Recherche Scientifique
Université Larbi Tébessi

Faculté des Sciences Exactes
et des Sciences de la Nature et de la Vie
Département Sciences de la Matière



*A*ttestation de *P*articipation

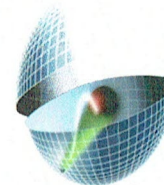

الدورة الوطنية الأولى حول الفيزياء النظرية والتطبيقية
Le 1^{er} Séminaire national sur
la Physique Appliquée et Théorique

SPAT 2014

Tébessa 16 - 17 Décembre 2014

LPAT

Je soussigné, Monsieur Professeur, **Faïçal Chemam**, Président du comité d'organisation,
que le(s) chercheur(s):

A. Zerarka, W. Djoudi

a (ont) participé, avec communication Poster intitulée :

**The Construction Of Exact Solutions For The Nonlinear Lattice Equation
Via coth And csch Functions Method**

Le Président du comité d'organisation

Pr. **F. Chemam**



CERTIFICATE

Participation in the conference OPAL 2015

I, Prof. Omar Lamrous, President of the Optical and Photonics Algerian Society, certifies that Mr. / Ms **Warda Djoudi**

has presented an Poster Communication entitled : **Exactly Fractional Travelling Wave Solutions Of Nonlinear Equation Via Some Fractional Transformations**

in the International Conference Optics and Photonics Algeria (OPAL) 2015 held in Algiers (USTHB) during December 14-15, 2015.

Co-authors: **A. Zerarka**



United Nations
Educational, Scientific and
Cultural Organization



INTERNATIONAL
YEAR OF LIGHT
2015

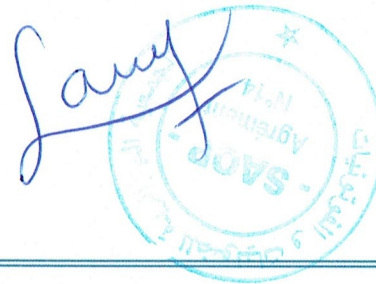

Chair of OPALS
Pr. O. LAMROUS

CERTIFICATE OF PRESENTATION

This certificate is awarded to
DJOUDI WARDA

in oral and technical presentation, recognition and appreciation of research
contributions to ICNMP 2015 : XIII International Conference on
Nonlinear Mathematical Physics

The Construction of Exact Solutions for the Nonlinear Lattice Equation via Coth and CsCh Functions Method
A. Zerarka, W. Djoudi

INTERNATIONAL SCIENTIFIC RESEARCH AND EXPERIMENTAL DEVELOPMENT

ISTANBUL, TURKEY

FEBRUARY 16-17, 2015



CERTIFICATE OF PRESENTATION

This certificate is awarded to
DJOUDI WARDA

in oral and technical presentation, recognition and appreciation of research
contributions to ICMCMP 2015 : XIII International Conference on
Mathematical and Computational Methods in Physics

Symbolic Computational of Nonlinear Wave Equation via the Functional Variable Method
A. Zerarka, W. Djoudi

INTERNATIONAL SCIENTIFIC RESEARCH AND EXPERIMENTAL DEVELOPMENT

ISTANBUL, TURKEY

FEBRUARY 16-17, 2015



CERTIFICATE OF PRESENTATION

This certificate is awarded to
DJOUDI WARDA

in oral and technical presentation, recognition and appreciation of research
contributions to ICMIPA 2015 : XIII International Conference on
Mathematical Physics and Applications

Exactly Fractional Solutions of Nonlinear Lattice Equation via Some Fractional Transformations
A. Zerarka, W. Djoudi

INTERNATIONAL SCIENTIFIC RESEARCH AND EXPERIMENTAL DEVELOPMENT

ISTANBUL, TURKEY

FEBRUARY 16-17, 2015



Full Length Research Paper

Construction of some new exact structures for the nonlinear lattice equation

W. Djoudi and A. Zerarka*

Laboratory of Applied Mathematics, University Med Khider, BP145, 07000 Biskra; Algeria.

Received 23 October, 2014; Accepted 13 November, 2014

In the present work we examine a generalized coth and csch functions method to construct new exact travelling solutions to the nonlinear lattice equation. The technique of the homogeneous balance method is used to handle the appropriated solutions. Some exact solutions obtained are new.

Key words: Nonlinear lattice, travelling wave solutions.

INTRODUCTION

Several methods have been developed for analytic solving of nonlinear partial differential equations. Specially, almost all of these nonlinear model equations were appeared (Wang and Li, 2008; Korteweg and Vries, 1995; Khelil et al., 2006) to give different structures to the solutions. Besides traditional methods such as auto-Backlund transformation, Lie Groups, inverse scattering transformation and Miura's transformation, a vast variety of the direct methods for obtaining explicit travelling solitary wave solutions have been found (Zerarka and Foester, 2005; Ibrahim and El-Kalaawy, 2007; Lü, 2014a,b). The availability of symbolic computation packages can be facilitating many direct approaches to establish solutions to non-linear wave equations (Xu and Zhang, 2007; Özis and Yıldırım, 2008). Various extension forms of the sine-cosine and tanh methods proposed by Malfliet and Wazwaz have been applied to solve a large class of nonlinear equations (Malfliet 1996a,b; Wazwaz 2004; He and Wu, 2006a,b). More importantly, another mathematical treatment is established and used in the

analysis of these nonlinear problems, such as Jacobian elliptic function expansion method, the variational iteration method, pseudo spectral method, the averaging method, and many others powerful methods (Odibat and Momani, 2006; Rafei and Ganji, 2006; Yu, 2007; Zhu, 2007a,b; Lü and Peng, 2013a,b,c; Lü, 2013; Lü et al., 2010; Jia et al., 2014; Liu and Qian, 2011). The aim of this work is to propose an efficient approach to examine new developments in a direct manner without requiring any additional condition on the investigation of exact solutions with the coth and csch functions method for a lattice system. We expect that the presented method could lead to construct successfully many other solutions for a large variety of other nonlinear evolution equations.

ANALYSIS OF THE PROBLEM

We consider the following nonlinear problem for the lattice equation as:

*Corresponding author. E-mail: abzerarka@yahoo.fr

Author(s) agree that this article remain permanently open access under the terms of the [Creative Commons Attribution License 4.0 International License](https://creativecommons.org/licenses/by/4.0/)

$$R(u, u_t, u_x, u_y, u_z, u_{xy}, u_{yz}, u_{xz}, u_{xx}, \dots) = 0, \tag{1}$$

Here the subscripts represent partial derivatives, and $u(t, x, y, z, \dots)$ is an unknown function to be determined. We take the following transformation for the new wave variable as:

$$\xi = \sum_{i=0}^p \alpha_i \chi_i + \delta, \tag{2}$$

χ_i are distinct variables, and when $p = 1$, $\xi = \alpha_0 \chi_0 + \alpha_1 \chi_1 + \delta$, the quantities α_0, α_1 are called the wave pulsation ω and the wave number k respectively if χ_0, χ_1 are the variables t and x respectively. In the discrete case for the position x and with continuous variable for the time t , ξ becomes with some modifications $\xi_n = nd + ct + \delta$ and n is the discrete variable. d and δ are arbitrary constants and c is the velocity. We use the traveling wave reduction transformation for Equation (1) as:

$$u(\chi_0, \chi_1, \dots) = U(\xi), \tag{3}$$

and the chain rule

$$\frac{\partial}{\partial \chi_i} (\cdot) = \alpha_i \frac{d}{d\xi} (\cdot), \quad \frac{\partial^2}{\partial \chi_i \partial \chi_j} (\cdot) = \alpha_i \alpha_j \frac{d^2}{d\xi^2} (\cdot), \dots, \tag{4}$$

Upon using Equations (3) and (4), the nonlinear problem (1) becomes an ODE like

$$Q(U, U_\xi, U_{\xi\xi}, U_{\xi\xi\xi}, U_{\xi\xi\xi\xi}, \dots) = 0 \tag{5}$$

APPLICATIONS

The one-dimensional lattice equation (Zhu, 2007, 2008) is written as:

$$\frac{du(n,t)}{dt} - (a + bu(n,t) + u^2(n,t))[u(n+1,t) - u(n-1,t)] = 0, \tag{6}$$

We first combine the independent variables, into a wave variable using ξ_n as

$$\xi_n = nd + ct + \delta \tag{7}$$

and we take the travelling wave solutions of the system

(6) using Equation (7) as $u(n, t) = U(\xi_n)$. By using the chain rule (4), the system (6) can be obtained as follows:

$$cU_{\xi_n}(\xi_n) - (a + bU(\xi_n) + U^2(\xi_n))(U(\xi_{n+1}) - U(\xi_{n-1})) = 0, \tag{8}$$

Where subscript denotes the differential with respect to ξ_n .

THE COTH FUNCTION METHOD

Suppose that Equation (8) has the following solution:

$$U(\xi_n) = \sum_{j=0}^M A_j \coth^j(\xi_n), \tag{9}$$

Where M is an undetermined integer and A_j are coefficients to be determined later. In order to determine values of the parameter M , we balance the linear term of highest order in Equation (8) with the highest order nonlinear term. By simple calculation, we have $2M = M + 1$ and the solution (9) takes the form

$$U(\xi_n) = A_0 + A_1 \coth(\xi_n), \tag{10}$$

Substituting the solution (10) into Equation (8), and equating to zero the coefficients of all powers of $\coth^j(\xi_n)$ yields a set of algebraic equations for A_0, A_1 and c as:

$$\begin{aligned} bA_1 + 2A_0A_1 &= 0 \\ 2(a + bA_0 + A_0^2) &= c \coth(d) \\ -2A_1^2 \coth(d) &= c \end{aligned} \tag{11}$$

Solving the system of algebraic equations with the aid of Mathematical, we obtain

$$\begin{aligned} A_0 &= -\frac{b}{2}, \\ A_1 &= \pm \frac{\tanh(d)}{2} \sqrt{b^2 - 4a}, \\ c &= \frac{\tanh(d)}{2} (4a - b^2), \end{aligned} \tag{12}$$

and the two travelling wave solutions of the problem of interest follow

$$U_{\pm}(\xi_n) = -\frac{b}{2} \pm \frac{\tanh(d)}{2} \sqrt{b^2 - 4a} \coth \left[nd + \frac{\tanh(d)}{2} (4a - b^2)t + \delta \right] \tag{13}$$

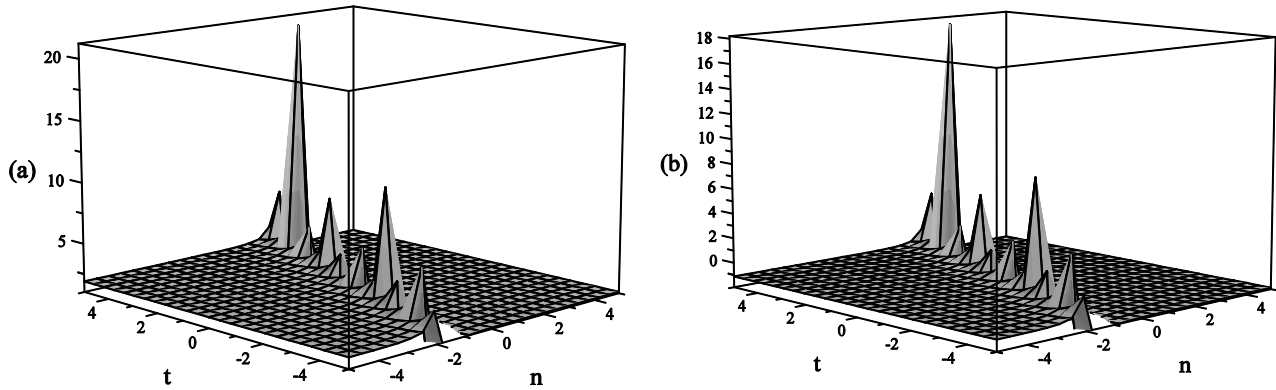

Figure 1. The graphs show the wave solutions of $u_{\pm}(n,t) = U_{\pm}(\xi_n)$ in Equation (13): (a) solution $u_+(n,t) = U_+(\xi_n)$, (b) solution $u_-(n,t) = U_-(\xi_n)$. For both curves: $a = 2, b = 3, d = 1, \delta = 0$.

Where d and δ are arbitrary constants.

Figure 1(a) and (b) show the physical waves $u_+(n,t) = U_+(\xi_n)$ and $u_-(n,t) = U_-(\xi_n)$ in Equations (13).

THE COTH-CSCH FUNCTION METHOD

The solutions of Equation (8) can be expressed in the form

$$U(\xi_n) = \alpha + \sum_{j=1}^M A_j \coth^j(\xi_n) + B_j \operatorname{csch}^j(\xi_n), \quad (14)$$

Where α, A_j and B_j are parameters to be determined.

The parameter M is found by balancing the highest-order linear term with the nonlinear terms, we obtain $M = 1$, and $U(\xi_n)$ becomes

$$U(\xi_n) = \alpha + A \coth(\xi_n) + B \operatorname{csch}(\xi_n), \quad (15)$$

Substituting Equation (15) into the relevant nonlinear differential Equation (8) and with the help of Mathematical we get a system of algebraic equations with respect to c, α, A and B .

$$\begin{aligned} Ac + 2A(A^2 + B^2) \coth(d) + 4AB^2 \operatorname{csch}(d) &= 0, \\ 4A^2 B \coth(d) + Bc \coth(d)^2 - 2B(\alpha^2 - B^2 + a + \alpha b) \operatorname{csch}(d) &= 0, \\ -(Bc) - 4A^2 B \coth(d) - 2B(A^2 + B^2) \operatorname{csch}(d) &= 0, \\ 2A(2\alpha B + Bb) &= 0, \\ 2A(2A\alpha + Ab) \coth(d) + 2B(2\alpha B + Bb) \operatorname{csch}(d) &= 0, \\ 2A(\alpha^2 - B^2 + a + \alpha b) - Ac \coth(d) &= 0 \end{aligned} \quad (16)$$

After some algebra, and with the help of Mathematical, the following values for the parameters c, α, A , and B are obtained:

First set

$$\begin{aligned} c &= \frac{1}{2}(4a - b^2) \tanh(d), \\ \alpha &= -\frac{b}{2}, \\ A &= \pm \frac{1}{2} \sqrt{b^2 - 4a} \tanh(d), \\ B &= 0, \end{aligned} \quad (17)$$

and the travelling solutions of Equation (17) are obtained as:

$$U_{\pm}(\xi_n) = -\frac{b}{2} \pm \frac{\tanh(d)}{2} \sqrt{b^2 - 4a} \coth(\xi_n), \quad (18)$$

Where $\xi_n = nd + \frac{\tanh(d)}{2}(4a - b^2)t + \delta$. The solutions (18) are similar to those obtained by the coth-function method Equation (13).

Second set

$$\begin{aligned} c &= \frac{1}{2}(4a - b^2) \sinh(d), \\ \alpha &= -\frac{b}{2}, \\ A &= 0, \\ B &= \pm \frac{1}{2} \sqrt{b^2 - 4a} \sinh(d), \end{aligned} \quad (19)$$

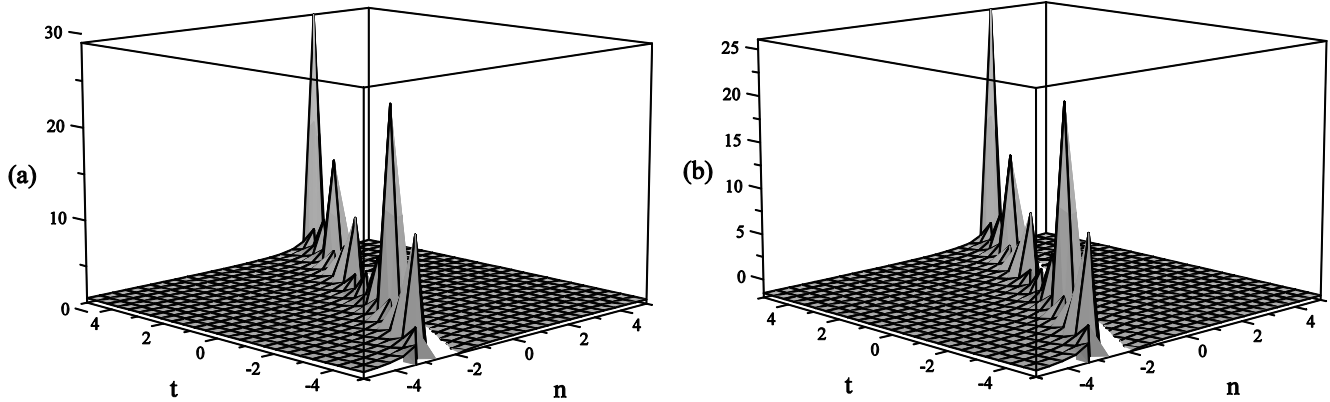

Figure 2. The graphs show the wave solution of $U_{\pm}(\xi_n)$ in (20): (a) solution $u_+(n,t) = U_+(\xi_n)$, (b) solution $u_-(n,t) = U_-(\xi_n)$. For both curves: $a = 2, b = 3, d = 1, \delta = 0$.

and the travelling solutions of Equation (19) are obtained as

$$U_{\pm}(\xi_n) = -\frac{b}{2} \pm \frac{\sinh(d)}{2} \sqrt{b^2 - 4a} \operatorname{csch}(\xi_n), \quad (20)$$

Where $\xi_n = nd + \frac{\sinh(d)}{2} (4a - b^2)t + \delta$. The portraits of solutions (20) for $U_{\pm}(\xi_n)$ are displayed in Figure 2(a) and (b).

Third set

$$\begin{aligned} c &= (4a - b^2) \tanh\left(\frac{d}{2}\right), \\ \alpha &= -\frac{b}{2}, \\ A &= \pm \frac{1}{2} \sqrt{b^2 - 4a} \tanh\left(\frac{d}{2}\right), \\ B &= \pm \frac{1}{2} \sqrt{b^2 - 4a} \tanh\left(\frac{d}{2}\right), \end{aligned} \quad (21)$$

Finally, third set admits the following two types:

$$U_{1\pm}(\xi_n) = -\frac{b}{2} - \frac{1}{2} \tanh\left(\frac{d}{2}\right) \sqrt{b^2 - 4a} (\coth(\xi_n) \pm \operatorname{csch}(\xi_n)), \quad (22)$$

and

$$U_{2\pm}(\xi_n) = -\frac{b}{2} + \frac{1}{2} \tanh\left(\frac{d}{2}\right) \sqrt{b^2 - 4a} (\coth(\xi_n) \pm \operatorname{csch}(\xi_n)), \quad (23)$$

Where $\xi_n = nd + (4a - b^2) \tanh\left(\frac{d}{2}\right)t + \delta$. The behaviors of solutions (22) and (23) for $U_{1+}(\xi_n)$ and $U_{2+}(\xi_n)$ are shown in Figure 3(a) and (b) respectively. The solutions given for the second and the third sets appear to be new.

CONCLUSION

The basic goal of this work, is to provide a new trial travelling solution to build the exact solutions to the nonlinear lattice equation. Two types of functions are used to find the exact solutions, which are named the coth-function and the coth-csch function methods. Eight variants of travelling wave solutions are obtained. The present method provides a reliable technique that requires less work if compared with the difficulties arising from computational aspect. The main advantage of this method is the flexibility to give exact solutions to nonlinear problems without linearization. We may conclude that, this method can also be extended to other high-dimensional nonlinear phenomena. It will be then interesting to study more general systems. These points will be investigated in a future research.

Conflict of Interest

The authors have not declared any conflict of interest.

ACKNOWLEDGEMENTS

Authors want to thank Pr W. Higg and Dr J. Karim for their valuable comments. The project is supported by Ministère de l'Enseignement et de la Recherche Scientifique (M.E.R.S): PNR n° 30/15/2011.

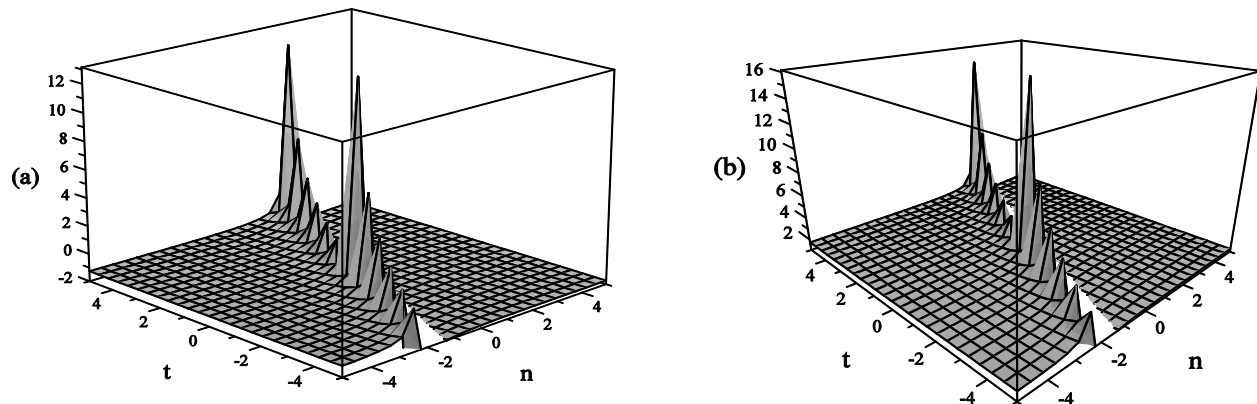
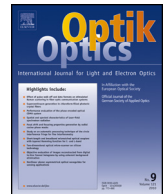

Figure 3. The graphs show the wave solution of $U_{1\pm}(\xi_n)$ and $U_{2\pm}(\xi_n)$ in (22) and (23) respectively: (a) solution $u_{1\pm}(n, t) = U_{1\pm}(\xi_n)$, (b) solution $u_{2\pm}(n, t) = U_{2\pm}(\xi_n)$. For both curves: $a = 2, b = 3, d = 1, \delta = 0$.

REFERENCES

- He JH, Wu XH (2006a). Exp-function method for nonlinear wave equations. *Chaos Solitons Fractals*. 30(3):700-708. <http://dx.doi.org/10.1016/j.chaos.2006.03.020>
- He JH, Wu XH (2006b). Construction of solitary solution and compacton-like solution by variational iteration method. *Chaos Solitons Fractals*. 29(1):108-113. <http://dx.doi.org/10.1016/j.chaos.2005.10.100>
- Ibrahim RS, El-Kalaawy OH (2007). Extended tanh-function method and reduction of nonlinear Schrödinger-type equations to a quadrature. *Chaos Solitons Fractals*. 31(4):1001-1008. <http://dx.doi.org/10.1016/j.chaos.2005.10.055>
- Jia L, Liu Q, Ma Z (2014). A good approximation of modulated amplitude waves in Bose-Einstein condensates. *Communications in Nonlinear Sci. Numer. Simul.* 19(8):2715-2723. <http://dx.doi.org/10.1016/j.cnsns.2013.12.034>
- Kheili N, Bensalah N, Saidi H, Zerarka A (2006). Artificial perturbation for solving the Korteweg-de Vries equation. *J. Zhejiang Univ. SCI. A* 7(12):2079-2082.
- Korteweg DJ, de Vries G (1995). On the change of the form of long waves advancing in a rectangular canal and on a new type of long stationary waves. *Philos. Mag.* P. 39.
- Liu Q, Qian D (2011). Modulated amplitude waves with nonzero phases in Bose-Einstein condensates. *J. Math. Phys.* 52(8):082702. <http://dx.doi.org/10.1063/1.3623415>
- Lü X (2014a). New bilinear Backlund transformation with multi-soliton solutions for the (2+1)-dimensional Sawada-Kotera model. *Nonlinear Dyn.* 76:161. <http://dx.doi.org/10.1007/s11071-013-1118-y>
- Lü X (2014b). Bright-soliton collisions with shape change by intensity redistribution for the coupled Sasa-Satsuma system in the optical fiber communications. *Communications in Nonlinear Science and Numerical Simulation*, 19:3969. <http://dx.doi.org/10.1016/j.cnsns.2014.03.013>
- Lü X, Peng M (2013a). Nonautonomous motion study on accelerated and decelerated solitons for the variable-coefficient Lenells-Fokas model. *Chaos*. 23:013122. <http://dx.doi.org/10.1063/1.4790827>
- Lü X, Peng M (2013b). Systematic construction of infinitely many conservation laws for certain nonlinear evolution equations in mathematical physics. *Commun. Nonlinear Sci. Numer. Simulat.* 18:2304. <http://dx.doi.org/10.1016/j.cnsns.2012.11.006>
- Lü X, Peng M (2013c). Painlevé-integrability and explicit solutions of the general two-coupled nonlinear Schrödinger system in the optical fiber communications. *Nonlinear Dyn.* 73:405. <http://dx.doi.org/10.1007/s11071-013-0795-x>
- Lü X (2013). Soliton behavior for a generalized mixed nonlinear Schrödinger model with N-fold Darboux transformation. *Chaos*. 23:033137. <http://dx.doi.org/10.1063/1.4821132>
- Lü X, Tian B, Zhang HQ, Xu T, Li H (2010). Integrability study on the generalized (2+1)-dimensional variable-coefficient Gardner model with symbolic computation. *Chaos*. 20:043125. <http://dx.doi.org/10.1063/1.3494154>
- Malfliet W (1996a). The tanh method: I. Exact solutions of nonlinear evolution and wave equations. *Phys. Scr.* 54:563-568. <http://dx.doi.org/10.1088/0031-8949/54/6/003>
- Malfliet W (1996b). The tanh method: II. Perturbation technique for conservative systems. *Phys. Scr.* 54:569-575. <http://dx.doi.org/10.1088/0031-8949/54/6/004>
- Odibat ZM, Momani S (2006). Application of variational iteration method to nonlinear differential equations of fractional order. *Int. J. Nonlinear Sci. Numer. Simul.* 7(1):27-34. <http://dx.doi.org/10.1515/IJNSNS.2006.7.1.27>
- Özis T, Yıldırım A (2008). Reliable analysis for obtaining exact soliton solutions of nonlinear Schrödinger (NLS) equation. *Chaos Solitons Fractals*. 38:209-212. <http://dx.doi.org/10.1016/j.chaos.2006.11.006>
- Rafei M, Ganji DD (2006). Explicit solutions of Helmholtz equation and fifth-order KdV equation using homotopy perturbation method. *Int. J. Nonlinear Sci. Numer. Simul.* 7(3):321-328. <http://dx.doi.org/10.1515/IJNSNS.2006.7.3.321>
- Wang DS, Li H (2008). Symbolic computation and non-travelling wave solutions of (2+1)-dimensional nonlinear evolution equations. *Chaos Solitons Fractals*. 38:383-390. <http://dx.doi.org/10.1016/j.chaos.2007.07.062>
- Wazwaz AM (2004). The tanh method for travelling wave solutions of nonlinear equations. *Appl. Math. Comput.* 154(3):713-23. [http://dx.doi.org/10.1016/S0096-3003\(03\)00745-8](http://dx.doi.org/10.1016/S0096-3003(03)00745-8)
- Xu LP, Zhang JL (2007). Exact solutions to two higher order nonlinear Schrödinger equations. *Chaos Solitons Fractals*. 31:937-942. <http://dx.doi.org/10.1016/j.chaos.2005.10.063>
- Yu YX (2007). Rational formal solutions of hybrid lattice equation. *Appl. Math. Comput.* 186:474-482. <http://dx.doi.org/10.1016/j.amc.2006.07.112>
- Zerarka A, Foester VG (2005). Separation method for solving the generalized Korteweg --de Vries equation. *Comm. Nonlinear. Sci. Numer. Simul.* 10:217-225. <http://dx.doi.org/10.1016/j.cnsns.2003.09.003>
- Zhu SD (2007a). Exp-function method for the hybrid-lattice systems. *Int. J. Nonlinear Sci. Numer. Simul.* 8:461-464. <http://dx.doi.org/10.1515/IJNSNS.2007.8.3.465>
- Zhu SD (2007b). Exp-function method for the discrete mKdV lattice. *Int. J. Nonlinear Sci. Numer. Simul.* 8:465-468. <http://dx.doi.org/10.1515/IJNSNS.2007.8.3.461>
- Zhu SD (2008). Discrete (2+1)-dimensional Toda lattice equation via exp-function method. *Phys. Lett. A* 372(5):654-657. <http://dx.doi.org/10.1016/j.physleta.2007.07.085>



Original research article

Exact structures for the KdV–mKdV equation with variable coefficients via the functional variable method



W. Djoudi, A. Zerarka*

Labo of Applied Mathematics, University Med Khider, BP145, 07000 Biskra, Algeria

ARTICLE INFO

Article history:

Received 16 May 2016

Accepted 19 July 2016

Keywords:

Nonlinear soliton

Travelling wave solutions

Functional variable

Homogeneous balance

KdV–mKdV

ABSTRACT

In this study we introduce the functional variable method (fvm for short) for obtaining new exact travelling solutions of the combined KdV–mKdV equation. The technique of the homogeneous balance method is used in second stage to handle the appropriated solutions. We show that, the method is straightforward and concise for several kind of nonlinear problems. Many new exact traveling wave solutions are successfully obtained.

© 2016 Elsevier GmbH. All rights reserved.

1. Introduction

A considerable research work has been invested to study the systems of nonlinear partial differential equations. Several methods [1–12] have been proposed to handle a wide variety of linear and non-linear wave equations. As is well known, the description of these nonlinear model equations were appeared to supply different structures to the solutions. Among these are the auto-Backlund transformation, inverse scattering method, Hirota method, Miura's transformation.

The availability of symbolic computation packages can be facilitate many direct approaches to establish solutions to non-linear wave equations [13–17]. Various extension forms of the sine-cosine and tanh methods proposed by Mal'fiet and Wazwaz have been applied to solve a large class of nonlinear equations [18,19]. More importantly, another mathematical treatment is established and used in the analysis of these nonlinear problems, such as Jacobian elliptic function expansion method, the variational iteration method, pseudo spectral method, and many others powerful methods [20,21].

One of the major goals of the present article is to provide an efficient approach based on the functional variable method to examine new developments in a direct manner without requiring any additional condition on the investigation of exact solutions for the combined KdV–mKdV equation. Abundant exact solutions are obtained together with the aid of symbol calculation software, such as Mathematica.

2. Basic idea of the method fvm

According to the idea proposed in our paper [22], this method can be presented as follows. The governing equation written in several independent variables can be expressed as

$$R(u, u_t, u_x, u_y, u_z, u_{xy}, u_{yz}, u_{xz}, u_{xx}, \dots) = 0, \quad (1)$$

* Corresponding author.

E-mail address: abzerarka@yahoo.fr (A. Zerarka).

where the subscripts denote differentiation, while $u(t, x, y, z, \dots)$ is an unknown function to be determined. Eq. (1) is a nonlinear partial differential equation that is not integrable, in general. Sometime it is difficult to find a complete set of solutions. If the solutions exist, there are many methods which can be used to handle these nonlinear equations.

The following transformation is used for the new wave variable as

$$\xi = \sum_{i=0}^p \alpha_i \chi_i + \delta, \quad (2)$$

χ_i are distinct variables, and when $p=1$, $\xi = \alpha_0 \chi_0 + \alpha_1 \chi_1 + \delta$, and if the quantities α_0, α_1 are constants, then, they are called the wave pulsation ω and the wave number k respectively if χ_0, χ_1 are the variables t and x respectively. We give the traveling wave reduction transformation for Eq. (1) as

$$u(\chi_0, \chi_1, \dots) = U(\xi), \quad (3)$$

and the chain rule

$$\frac{\partial}{\partial \chi_i} (\cdot) = \alpha_i \frac{d}{d\xi} (\cdot), \quad \frac{\partial^2}{\partial \chi_i \partial \chi_j} (\cdot) = \alpha_i \alpha_j \frac{d^2}{d\xi^2} (\cdot), \dots \quad (4)$$

Upon using (3) and (4), the nonlinear problem (1) with suitably chosen variables becomes an ordinary differential equation (ODE) like

$$Q(U, U_\xi, U_{\xi\xi}, U_{\xi\xi\xi}, U_{\xi\xi\xi\xi}, \dots) = 0 \quad (5)$$

A transformation of functions as variables can sometimes be found that transforms a nonlinear equation into a linear equation, or some other nonlinear equation easily integrable. Thus, if the unknown function U is treated as a functional variable in the form

$$U_\xi = F(U), \quad (6)$$

then, the solution can be found by the relation

$$\int \frac{dU}{F(U)} = \xi + \alpha_0, \quad (7)$$

here α_0 is a constant of integration which is set equal to zero for convenience. Some successive differentiations of U in terms of F are given as

$$\begin{aligned} U_{\xi\xi} &= \frac{1}{2}(F^2)', \\ U_{\xi\xi\xi} &= \frac{1}{2}(F^2)'' \sqrt{F^2}, \\ U_{\xi\xi\xi\xi} &= \frac{1}{2} [(F^2)''' F^2 + (F^2)'' (F^2)'], \\ &\vdots, \end{aligned} \quad (8)$$

where “'” stands for $\frac{d}{dU}$. The ordinary differential equation (5) can be reduced in terms of U, F and its derivatives upon using the expressions of (8) into (5) gives

$$R(U, F, F', F'', F''', F^{(4)}, \dots) = 0 \quad (9)$$

The key idea of this particular form (9) is of special interest because it admits analytical solutions for a large class of nonlinear wave type equations. After integration, the Eq. (9) provides the expression of F , and this in turn together with (6) give the relevant solutions to the original problem.

3. KdV–mKdV solutions

Let us consider the KdV–mKdV equation [23–25] is written as

$$u_t - 6h_0(t)uu_x - 6h_1(t)u^2u_x + h_2(t)u_{xxx} - h_3(t)u_x + h_4(t)(Au + xu_x) = 0, \quad (10)$$

This equation arises in many physical problems including the motions of waves in nonlinear optics, plasma or fluids, water waves, ion-acoustic waves in a collisionless plasma, where $h_i, i=0, 1, 2, 3, 4$, are arbitrary smooth model functions that symbolize the coefficients of the time variable t and the subscripts denote the partial differentiations with respect to the corresponding variable. The first element u_t designates the evolution term which governs how the wave evolves with respect

to time, while the second one shows the term of dispersion. We first combine the independent variables, into a wave variable using ξ as

$$\xi = \alpha(t)x + \beta(t), \tag{11}$$

where α and β are time-dependent functions, and we write the travelling wave solutions of Eq. (10) with (11) as $u(x, t) = U(t, \xi)$. By using the chain rule (4), the differential equation (10) can be transformed as:

$$U_t + (\alpha_t x + \beta_t) U' - 6\alpha h_0(t) U U' - 6\alpha h_1(t) U^2 U' + \alpha^3 h_2(t) U''' - \alpha h_3(t) U' + h_4(t) (AU + \alpha x U') = 0, \tag{12}$$

where the primes denote the derivatives with respect to the second argument, and it is known that many nonlinear models with linear dispersion coefficient $h_2(t)$ and convection coefficient $h_0(t)$ generate quite stable structures such as the solitons and kink solutions.

4. Partial structures

In order to prepare the complete solution for Eq. (10), we begin with the special case when $h_4 = 0$, α , β and $h_i, i = 0, 1, 2, 3$ are constant functions. Thus, Eq. (10) is then integrated as long as all terms contain derivatives where integration constants are considered zeros, and it looks like following:

$$[\beta_t - \alpha h_3(t) + (\alpha_t + h_4(t)\alpha)x] U - 3\alpha h_0(t) U^2 - 2\alpha h_1(t) U^3 + \alpha^3 h_2(t) U'' = 0, \tag{13}$$

from Eq. (13) and the method fvm, we obtain

$$F(U) = U' = \sqrt{aU^2 + bU^3 + cU^4}, \tag{14}$$

where

$$\begin{aligned} a &= \frac{h_3(t)}{a^2 h_2(t)}, \\ b &= \frac{2h_0(t)}{a^2 h_2(t)}, \\ c &= \frac{h_1(t)}{a^2 h_2(t)} \end{aligned} \tag{15}$$

From (14), we obtain the desired solution as [5,26]

$$U(\xi) = \begin{cases} \frac{2a \operatorname{sech}(\sqrt{a}\xi)}{\varepsilon \sqrt{b^2 - 4ac} - b \operatorname{sech}(\sqrt{a}\xi)}, & a > 0, b^2 - 4ac > 0, \\ \frac{2acsch(\sqrt{a}\xi)}{\varepsilon \sqrt{4ac - b^2} - bcsch(\sqrt{a}\xi)}, & a > 0, b^2 - 4ac < 0, \\ -ab \operatorname{sech}^2\left(\frac{\sqrt{a}}{2}\xi\right), & a > 0, \\ \frac{b^2 - ac \left(1 + \varepsilon \tanh\left(\frac{\sqrt{a}}{2}\xi\right)\right)}{-\frac{a}{b} \left[1 + \varepsilon \tanh\left(\frac{\sqrt{a}}{2}\xi\right)\right]}, & a > 0, b^2 = 4ac, \\ & \varepsilon = \pm 1 \end{cases} \tag{16}$$

5. Full structures

Now we reveal the main features of solutions by working directly from (14) to (16). Let us take a closer look at the equation in presence of the term h_4 and α , β and $h_i, i = 0, 1, 2, 3, 4$ are time-dependent functions. According to the previous situation, we expand the solution of Eq. (12) in the form:

$$U(t, \xi) = \sum_{k=0}^M q_k \Phi^k(\xi), \tag{17}$$

where Φ satisfies Eq. (14) as

$$\Phi' = \sqrt{\lambda \Phi^2 + \mu \Phi^3 + \nu \Phi^4}, \tag{18}$$

and the possible structures are known from (16), and λ , μ and ν are free parameters and M is an undetermined integer and q_k are coefficients to be determined later. One of the most useful techniques for obtaining the parameter M in (17) is the homogeneous balance method. Substituting from (17) into Eq. (12) and by making balance between the linear term (cubic dispersion) U''' and the nonlinear term (cubic nonlinearity) U^2U' to determine the value of M , and by simple calculation we have got that $M + 1 = 3M - 1$, this in turn gives $M = 1$, and the solution (17) takes the form

$$U(t, \xi) = q_0 + q_1 \Phi(\xi) \tag{19}$$

Now, we substitute (19) into (12) along with (18) and set each coefficient of $\Phi^k(\Phi')^l$ and $x\Phi'$ ($k=0, 1, 2$ and $l=0, 1$) to zero to obtain a set of algebraic equations for q_0, q_1, α , and β as,

$$\frac{dq_0}{dt} + Ah_4q_0 = 0, \tag{20a}$$

$$\frac{dq_1}{dt} + Ah_4q_1 = 0, \tag{20b}$$

$$\frac{d\alpha}{dt} + h_4\alpha = 0, \tag{20c}$$

$$\frac{d\beta}{dt} - 6h_0q_0\alpha - 6h_1q_0^2\alpha + h_2\alpha^3\lambda - h_3\alpha = 0, \tag{20d}$$

$$h_2\alpha^2\mu - 4h_1q_0q_1 - 2h_0q_1 = 0, \tag{20e}$$

$$h_2\alpha^2\nu - h_1q_1^2 = 0, \tag{20f}$$

Solving the system of algebraic equations, we would end up with the explicit pulse parameters for q_0, q_1, α and β , we obtain

$$q_0(t) = q_{00}e^{-A \int h_4 dt}, \tag{21a}$$

$$q_1(t) = q_{10}e^{-A \int h_4 dt}, \tag{21b}$$

$$\alpha(t) = \alpha_0 e^{-\int h_4 dt}, \tag{21c}$$

$$\beta(t) = \int (6h_0q_0\alpha + 6h_1q_0^2\alpha - h_2\alpha^3\lambda + h_3\alpha) dt + \beta_0, \tag{21d}$$

where q_{00}, q_{10}, α_0 and β_0 are the integration constants and are identified from initial data of the pulse. Notice that (20e) and (20f) serve as constraint relations between the coefficient functions and the pulse parameters.

From (20e) to (20f), one may find that

$$q_{00} - \frac{\mu}{4\nu}q_{10} = -\frac{h_0}{2h_1}e^{A \int h_4 dt}, \tag{22}$$

and

$$\frac{\alpha_0}{q_{10}} = \sqrt{\frac{h_1}{h_2\nu}} e^{(1-A) \int h_4 dt}, \tag{23}$$

$$h_1h_2\nu > 0,$$

which indicate that (22) and (23) must be satisfied to assure the existence and the formation process of soliton structures. Taking account of these data, we attain the exact solutions for Eq. (12) as following

$$u_1(x, t) = e^{-A \int h_4 dt} \left(q_{00} + q_{10} \frac{2\lambda \operatorname{sech}(\sqrt{\lambda}\xi)}{\varepsilon\sqrt{\mu^2 - 4\lambda\nu} - \mu \operatorname{sech}(\sqrt{\lambda}\xi)} \right), \quad \lambda > 0, \mu^2 - 4\lambda\nu > 0, \tag{24a}$$

$$u_2(x, t) = e^{-A \int h_4 dt} \left(q_{00} + q_{10} \frac{2\lambda \operatorname{csch}(\sqrt{\lambda}\xi)}{\varepsilon\sqrt{4\lambda\nu - \mu^2} - \mu \operatorname{csch}(\sqrt{\lambda}\xi)} \right), \quad \lambda > 0, \mu^2 - 4\lambda\nu < 0, \tag{24b}$$

$$u_3(x, t) = e^{-A \int h_4 dt} \left(\frac{-\lambda\mu \operatorname{sech}^2\left(\frac{\sqrt{\lambda}}{2}\xi\right)}{\mu^2 - \lambda\nu \left(1 + \varepsilon \tanh\left(\frac{\sqrt{\lambda}}{2}\xi\right)\right)^2} \right), \quad \lambda > 0, \tag{24c}$$

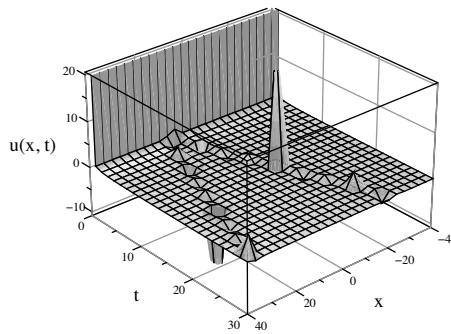

Fig. 1. The graph shows the wave solution of $u_1(x, t) = U_1(t, \xi)$ in (24a). The curve, was performed with the parameters $A = 1, \mu = 4, \lambda = 1, \nu = 3, \varepsilon = 1, q_{00} = \frac{4}{3}, q_{10} = 1, \alpha_0 = \sqrt{2/3}, \beta_0 = 0, h_0 = 4, h_1 = -2t, h_2 = -t, h_3 = \frac{2}{t}, h_4 = t^{-1}$.

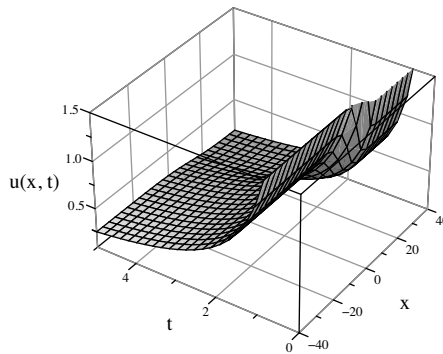

Fig. 2. The evolution of the wave solution $u_4(x, t) = U_4(t, \xi)$ given by Eq. (24d), input parameters: $A = 1, \mu = 4, \lambda = 1, \nu = 4, \varepsilon = 1, q_{00} = 4/3, q_{10} = 1, \alpha_0 = \sqrt{1/2}, \beta_0 = 0, h_0 = 4, h_1 = -2t, h_2 = -t, h_3 = 2/t, h_4 = t^{-1}$.

$$u_4(x, t) = e^{-A \int h_4 dt} \left(q_{00} - q_{10} \frac{\lambda}{\mu} \left[1 + \varepsilon \tanh \left(\frac{\sqrt{\lambda}}{2} \xi \right) \right] \right), \quad \lambda > 0, \mu^2 = 4\lambda\nu, \tag{24d}$$

where $(u_i(x, t) = U_i(t, \xi), i = 1, 2, 3, 4), \xi = \alpha(t)x + \beta(t)$ and $\varepsilon = \pm 1$.

We note that, Eq. (18) admits several other types of solutions, it is easy to see that we can include more solutions as listed in [5], we omit these results here. The propagation velocity of the soliton pulse is related to parameters describing the process and is expressed by the relation $v(t) = (d\beta(t)/\alpha(t)/dt)$, and the inverse widths are given by $\alpha(t)\sqrt{\lambda}$ and $\alpha(t)(\sqrt{\lambda}/2)$, which exist provided $\lambda > 0$ for the wave solutions ((24a), (24b)) and ((24c), (24d)) respectively. All the solutions found have been verified through substitution with the help of Mathematica software. However, to our best knowledge, all solutions obtained are completely new except the solution 3 is just the result found by Triki et al. [23] with a different route using directly the ansatz method.

A qualitative plot of the solution (24a), $u_1(x, t) = U_1(t, \xi)$ is presented in Fig. 1, and Fig. 2 shows the physical wave (24d), $u_4(x, t) = U_4(t, \xi)$. It is apparent that the amplitude contributes to the formation of solitons mainly through the model function $h_4(t)$ (for full structures). Consequently, in the absence of the coefficient function $h_4(t)$ or the parameter A , the partial and full structures become substantially equivalent versions.

6. Conclusion

In this work, we applied a new analytical technique namely, the functional variable method (fvm) to establish some new exact analytic wave structures to the KdV–mKdV equation with time-dependent coefficients. On one side, for the first case study, we obtained the limited solutions using the partial structures for the function $h_4 = 0$. On the other side, for the second case study, we introduced the results obtained for the partial structures to solve the KdV–mKdV nonlinear differential equation for the full structures in the presence of the function $h_4 \neq 0$. Four variants of complete travelling wave solutions are obtained. The present method provides a reliable technique that requires less work if compared with the difficulties arising from computational aspect. The main advantage of this method is the flexibility to give exact solutions to nonlinear PDEs without any need for perturbation techniques, and does not require linearizing or discrediting. All calculations are performed using Mathematica.

We may conclude that, this method can be easily extended to find the solution of some high-dimensional nonlinear problems. These points will be investigated in a future research.

Acknowledgment

We want to thank Pr. W. Higg and Dr. J. Wang for their valuable comments. This work is partially supported by M.E.R.S (Ministère de l'Enseignement et de la Recherche Scientifique): PNR no 30/15/2011.

References

- [1] D.-S. Wang, H. Li, Symbolic computation and non-travelling wave solutions of $(2 + 1)$ -dimensional nonlinear evolution equations, *Chaos Solitons Fract.* 38 (2008) 383–390.
- [2] D.J. Korteweg, G. de Vries, On the change of the form of long waves advancing in a rectangular canal and on a new type of long stationary waves, *Philos. Mag.* 39 (1895).
- [3] N.C. Freeman, R.S. Johnson, Shallow water waves on shear flows, *J. Fluid. Mech.* 42 (1970) 401–409.
- [4] A. Zerarka, Solution of Korteweg-de Vries equation by decomposition method, *Int. Cong. Math. Appl. Ingeen. Sc, Casa* (1996).
- [5] Sirendaoreji, Auxiliary equation method and new solutions of Klein–Gordon equations, *Chaos Solitons Fract.* 31 (2007) 943–950.
- [6] Sirendaoreji, New exact travelling wave solutions for the Kawahara and modified Kawahara equations, *Chaos Solitons Fract.* 19 (2004) 147–150.
- [7] A.M. Wazwaz, Analytic study on nonlinear variants of the RLW and the PHI-four equation, *Commun. Nonlinear Sci. Numer. Simul.* 12 (2007) 314–327.
- [8] J.M. Dye, A. Parker, An inverse scattering scheme for the regularized long-wave equation, *J. Math. Phys.* 41 (5) (2000) 2889–2904.
- [9] R.T. Benjamin, J.L. Bona, J.J. Mahony, Model equations for long waves in nonlinear dispersive systems, *Philos. Trans. R. Soc. Lond.* 272 (1972) 47–78.
- [10] N. Khelil, N. Bensalah, H. Saidi, A. Zerarka, Artificial perturbation for solving the Korteweg-de Vries equation, *J. Zhejiang Univ. Sci. A* 7 (12) (2006) 2079–2082.
- [11] Zerarka, V.G. Foester, Separation method for solving the generalized Korteweg-de Vries equation, *Commun. Nonlinear Sci. Numer. Simul.* 10 (2005) 217–225.
- [12] A.M. Wazwaz, New solitary-wave special solutions with compact support for the nonlinear dispersive $K(m, n)$ equations, *Chaos Solitons Fract.* 13 (2) (2002) 321–330.
- [13] R. Hirota, Exact solution of KdV equation for multiple collisions of solitons, *Phys. Rev. Lett.* 27 (1971) 1192–1194 (1).
- [14] L. Iskandar, New numerical solution of the Korteweg-de Vries equation, *Appl. Numer. Math.* 5 (1989) 215–221.
- [15] L.P. Xu, J.L. Zhang, Exact solutions to two higher order nonlinear Schrödinger equations, *Chaos Solitons Fract.* 31 (2007) 937–942.
- [16] F. Jinqing, Y. Wei-Guang, Adomian's decomposition method for the solution of generalized Duffing equations, in: *Proc. 1992 Internat. Workshop on Mathematics Mechanization, Beijing, China, 1992.*
- [17] Zhou Yubin, Wang Mingliang, Wang Yueming, Periodic wave solutions to a coupled KdV equations with variable coefficients, *Phys. Lett. A* 308 (2003) 3136.
- [18] W. Malfliet, Solitary wave solutions of nonlinear wave equations, *Am. J. Phys.* 60 (7) (1992) 650–654.
- [19] Fan Engui, Zhang Jian, Applications of the Jacobi elliptic function method to special-type nonlinear equations, *Phys. Lett. A* 305 (6) (2002) 383–392.
- [20] E. Yomba, The extended F-expansion method and its application for solving the nonlinear wave, CKGZ, GDS, DS and GZ equations, *Phys. Lett. A* 340 (2005) 149–160.
- [21] J.B. Liu, K.Q. Yang, The extended F-expansion method and exact solutions of nonlinear PDEs, *Chaos Solitons Fract.* 22 (2004) 111–121.
- [22] A. Zerarka, S. Ouamane, A. Attaf, Construction of exact solutions to a family of wave equations by the functional variable method, *Waves Random Complex Media* 21 (1) (2011) 44–56.
- [23] H. Triki, Thiab R. Taha, A.M. Wazwaz, Solitary wave solutions for a generalized KdV–mKdV equation with variable coefficients, *Math. Comput. Simul.* 80 (2010) 1867–1873.
- [24] X. Li, M. Wang, A sub-ODE method for finding exact solutions of a generalized KdV–mKdV equation with high-order nonlinear terms, *Phys. Lett. A* 361 (2007) 115–118.
- [25] A.M. Wazwaz, Analytic study for fifth-order KdV-type equations with arbitrary power nonlinearities, *Commun. Nonlinear Sci. Numer. Simul.* 12 (2007) 904–909.
- [26] Yomba Emmanuel, Construction of new soliton-like solutions for the $(2 + 1)$ dimensional Kadomtsev–Petviashvili equation, *Chaos Solitons Fract.* 22 (2) (2004 October) 321–325.



Received: 15 June 2016
Accepted: 25 July 2016

*Corresponding author: A. Zerarka,
Laboratory of Applied Mathematics,
University Med Khider, BP145, 07000
Biskra, Algeria
E-mails: abzerarka@yahoo.fr, azerarka@hotmail.fr

Reviewing editor:
Carlo Cattani, University of Tuscany, Italy

Additional information is available at
the end of the article

APPLIED & INTERDISCIPLINARY MATHEMATICS | RESEARCH ARTICLE

Exact solutions for the KdV–mKdV equation with time-dependent coefficients using the modified functional variable method

W. Djoudi¹ and A. Zerarka^{1*}

Abstract: In this article, the functional variable method (fvm for short) is introduced to establish new exact travelling solutions of the combined KdV–mKdV equation. The technique of the homogeneous balance method is used in second stage to handle the appropriated solutions. We show that, the method is straightforward and concise for several kinds of nonlinear problems. Many new exact travelling wave solutions are successfully obtained.

Subjects: Applied Mathematics; Computer Mathematics; Dynamical Systems; Mathematical Physics; Mathematics & Statistics; Science

Keywords: nonlinear soliton; travelling wave solutions; functional variable; homogeneous balance; KdV–mKdV

AMS subject classifications: 35Cxx; 35Bxx; 74J30; 70Kxx; 74J35

1. Introduction

There are several forms of nonlinear partial differential equations that have been presented in the past decades to investigate new exact solutions. Several methods (Benjamin, Bona, & Mahony, 1972; Dye & Parker, 2000; Freeman & Johnson, 1970; Khelil, Bensalah, Saidi, & Zerarka, 2006; Korteweg & de Vries, 1895; Sirendaoreji, 2004, 2007; Wang & Li, 2008; Wazwaz, 2002, 2007a; Zerarka, 1996,

ABOUT THE AUTHORS

W. Djoudi obtained her master's degree from the University of Science and Technology in 2011. She is currently pursuing her PhD degree at the Laboratory of Mathematics. Her research interest includes the nonlinear structures of resonant interaction and dispersion of waves.

A. Zerarka is Professor of Physics and Applied Mathematics at the University Med Khider at Biskra, Algeria. He obtained his PhD from the University of Bordeaux, France. His domain of interest is theoretical physics and applied mathematics. He has been teaching and conducting research since 1981, has widely published in international journals and he is the author and co-author of numerous refereed papers. He is the reviewer of numerous papers (Elsevier, Taylor and Francis, Wiley, Springer, Inderscience, Academicjournals and more). He is an active member of the Academy of Science, New York.

PUBLIC INTEREST STATEMENT

We present an important direct formulation namely the functional variable method for constructing exact analytical solutions of nonlinear partial differential equations. This method is based on the linear combination of the unknown function assumed as a variable of the system, and the technique of the homogeneous balance is used to handle the appropriated solutions which include new exact travelling waves and solitons. We note that almost all of the solutions obtained in the literature are based on trial functions with some free parameters or on the supposition of a known ansatz. In general, these techniques offer solutions that are not unique. The main advantage of this method is the flexibility to give exact solutions to nonlinear PDEs without any need for perturbation techniques, and does not require linearizing or discrediting. Another possible merit is that, this method only uses the techniques of direct integration for integrable models.

2005) have been proposed to handle a wide variety of linear and nonlinear wave equations. As is well known, the description of these nonlinear model equations appeared to supply different structures to the solutions. Among these are the auto-Backlund transformation, inverse scattering method, Hirota method, Miura's transformation.

The availability of symbolic computation packages can facilitate many direct approaches to establish solutions to nonlinear wave equations (Hirota, 1971; Iskandar, 1989; Jinqing & Wei-Guang, 1992; Xu & Zhang, 2007; Zhou, Wang, & Wang, 2003). Various extension forms of the sine-cosine and tanh methods proposed by Malfliet and Wazwaz have been applied to solve a large class of nonlinear equations (Fan & Zhang, 2002; Malfliet, 1992). More importantly, another mathematical treatment is established and used in the analysis of these nonlinear problems, such as Jacobian elliptic function expansion method, the variational iteration method, pseudo spectral method and many other powerful methods (Liu & Yang, 2004; Yomba, 2005).

One of the major goals of the present article is to provide an efficient approach based on the functional variable method to examine new developments in a direct manner without requiring any additional condition on the investigation of exact solutions for the combined KdV-mKdV equation. Abundant exact solutions are obtained together with the aid of symbol calculation software, such as Mathematica.

2. Description of the method fvm

To clarify the basic idea of fvm proposed in our paper (Zerarka, Ouamane, & Attaf, 2011), we present the governing equation written in several independent variables as

$$R(u, u_t, u_x, u_y, u_z, u_{xy}, u_{yz}, u_{xz}, u_{xx}, \dots) = 0, \tag{1}$$

where the subscripts denote differentiation, while $u(t, x, y, z, \dots)$ is an unknown function to be determined. Equation (1) is a nonlinear partial differential equation that is not integrable, in general. Sometime it is difficult to find a complete set of solutions. If the solutions exist, there are many methods which can be used to handle these nonlinear equations.

The following transformation is used for the new wave variable as

$$\xi = \sum_{i=0}^p \alpha_i \chi_i + \delta, \tag{2}$$

where χ_i are distinct variables, and when $p = 1$, $\xi = \alpha_0 \chi_0 + \alpha_1 \chi_1 + \delta$, and if the quantities α_0, α_1 are constants, then, they are called the wave pulsation ω and the wave number k respectively, if χ_0, χ_1 are the variables t and x , respectively. We give the travelling wave reduction transformation for Equation (1) as

$$u(\chi_0, \chi_1, \dots) = U(\xi), \tag{3}$$

and the chain rule

$$\frac{\partial}{\partial \chi_i} (\cdot) = \alpha_i \frac{d}{d\xi} (\cdot), \quad \frac{\partial^2}{\partial \chi_i \partial \chi_j} (\cdot) = \alpha_i \alpha_j \frac{d^2}{d\xi^2} (\cdot), \dots \tag{4}$$

Upon using (3) and (4), the nonlinear problem (1) with suitably chosen variables becomes an ordinary differential equation (ODE) like

$$Q(U, U_\xi, U_{\xi\xi}, U_{\xi\xi\xi}, U_{\xi\xi\xi\xi}, \dots) = 0. \tag{5}$$

If we consider a function as a variable, it is sometimes easy to transform a nonlinear equation into a linear equation. Thus, if the unknown function U is treated as a functional variable in the form

$$U_\xi = F(U), \tag{6}$$

then, the solution can be found by the relation

$$\int \frac{dU}{F(U)} = \xi + a_0, \tag{7}$$

here a_0 is a constant of integration which is set equal to zero for convenience. Some successive differentiations of U in terms of F are given as

$$\begin{aligned} U_{\xi\xi} &= \frac{1}{2}(F^2)', \\ U_{\xi\xi\xi} &= \frac{1}{2}(F^2)'' \sqrt{F^2}, \\ U_{\xi\xi\xi\xi} &= \frac{1}{2}[(F^2)'''F^2 + (F^2)''(F^2)'], \\ &\vdots, \end{aligned} \tag{8}$$

where “'” stands for $\frac{d}{dU}$. The ordinary differential equation (5) can be reduced in terms of U, F and its derivatives upon using the expressions of (8) into (5) gives

$$R(U, F, F', F'', F''', F^{(4)}, \dots) = 0. \tag{9}$$

The key idea of this particular form (9) is of special interest because it admits analytical solutions for a large class of nonlinear wave type equations. After integration, the Equation (9) provides the expression of F , and this in turn together with (6) give the relevant solutions to the original problem.

3. KdV–mKdV solutions

Let us consider the KdV–mKdV equation (Li & Wang, 2007; Triki, Thiab, & Wazwaz, 2010; Wazwaz, 2007b) is written as

$$u_t - 6h_0(t)uu_x - 6h_1(t)u^2u_x + h_2(t)u_{xxx} - h_3(t)u_x + h_4(t)(Au + xu_x) = 0. \tag{10}$$

This equation arises in many physical problems including the motions of waves in nonlinear optics, plasma or fluids, water waves, ion-acoustic waves in a collisionless plasma, where $h_i, i = 0, 1, 2, 3, 4$, are arbitrary smooth model functions that symbolize the coefficients of the time variable t and the subscripts denote the partial differentiations with respect to the corresponding variable. The first element u_t designates the evolution term which governs how the wave evolves with respect to time, while the second one shows the term of dispersion. We first combine the independent variables, into a wave variable using ξ as

$$\xi = \alpha(t)x + \beta(t), \tag{11}$$

where α and β are time-dependent functions, and we write the travelling wave solutions of Equation (10) with (11) as $u(x, t) = U(t, \xi)$. Using the chain rule (4), the differential equation (10) can be transformed as:

$$U_t + (\alpha_t x + \beta_t)U' - 6\alpha h_0(t)UU' - 6\alpha h_1(t)U^2U' + \alpha^3 h_2(t)U''' - \alpha h_3(t)U' + h_4(t)(AU + \alpha x U') = 0, \tag{12}$$

where the primes denote the derivatives with respect to the argument ξ , and it is known that many nonlinear models with linear dispersion coefficient $h_2(t)$ and convection coefficient $h_0(t)$ generate quite stable structures such as the solitons and kink solutions.

4. Partial structures

In order to prepare the complete solution for Equation (10), we begin with the special case when $h_4 = 0$ and α, β and $h_i, i = 0, 1, 2, 3$ are constant functions. Thus, Equation (10) is then integrated as long as all terms contain derivatives where integration constants are considered zeros, and it looks like following:

$$-\alpha h_3(t)U - 3\alpha h_0(t)U^2 - 2\alpha h_1(t)U^3 + \alpha^3 h_2(t)U'' = 0, \tag{13}$$

from Equation (13) and the method fvm, we obtain

$$F(U) = U' = \sqrt{aU^2 + bU^3 + cU^4}, \tag{14}$$

where

$$\begin{aligned} a &= \frac{h_3(t)}{\alpha^2 h_2(t)}, \\ b &= \frac{2h_0(t)}{\alpha^2 h_2(t)}, \\ c &= \frac{h_1(t)}{\alpha^2 h_2(t)}. \end{aligned} \tag{15}$$

From (14), we obtain the desired solution as (Sirendaoreji, 2007; Yomba, 2004)

$$U(\xi) = \begin{cases} \frac{2a \operatorname{sech}(\sqrt{a}\xi)}{\varepsilon \sqrt{b^2 - 4ac} - b \operatorname{sech}(\sqrt{a}\xi)}, & a > 0, \quad b^2 - 4ac > 0, \\ \frac{2a \operatorname{csch}(\sqrt{a}\xi)}{\varepsilon \sqrt{4ac - b^2} - b \operatorname{csch}(\sqrt{a}\xi)}, & a > 0, \quad b^2 - 4ac < 0, \\ \frac{-ab \operatorname{sech}^2\left(\frac{\sqrt{a}}{2}\xi\right)}{b^2 - ac \left(1 + \varepsilon \tanh\left(\frac{\sqrt{a}}{2}\xi\right)\right)^2}, & a > 0, \\ -\frac{a}{b} \left[1 + \varepsilon \tanh\left(\frac{\sqrt{a}}{2}\xi\right) \right], & a > 0, \quad b^2 = 4ac, \\ \varepsilon = \pm 1. \end{cases} \tag{16}$$

5. Full structures

Now we reveal the main features of solutions by working directly from (14) to (16). Let us take a closer look at the equation in presence of the term h_4 and α, β and $h_i, i = 0, 1, 2, 3, 4$ are time-dependent functions. According to the previous situation, we expand the solution of Equation (12) in the form:

$$U(t, \xi) = \sum_{k=0}^M q_k \Phi^k(\xi), \tag{17}$$

where Φ satisfies Equation (14) as

$$\Phi' = \sqrt{\lambda \Phi^2 + \mu \Phi^3 + \nu \Phi^4}, \tag{18}$$

and the possible structures are known from (16), and λ, μ and ν are free parameters and M is an undetermined integer and q_k are coefficients to be determined later. One of the most useful techniques for obtaining the parameter M in (17) is the homogeneous balance method. Substituting from (17) into Equation (12) and by making balance between the linear term (cubic dispersion) U''' and the

nonlinear term (cubic nonlinearity) U^2U' to determine the value of M , and by simple calculation we have got that $M + 1 = 3M - 1$, this in turn gives $M = 1$, and the solution (17) takes the form

$$U(t, \xi) = q_0 + q_1 \Phi(\xi). \tag{19}$$

Now, we substitute (19) into (12) along with (18) and set each coefficient of $\Phi^k (\Phi')^l$ and $x\Phi'$ ($k = 0, 1, 2$ and $l = 0, 1$) to zero to obtain a set of algebraic equations for q_0, q_1, α , and β as,

$$\frac{dq_0}{dt} + Ah_4q_0 = 0, \tag{20a}$$

$$\frac{dq_1}{dt} + Ah_4q_1 = 0, \tag{20b}$$

$$\frac{d\alpha}{dt} + h_4\alpha = 0, \tag{20c}$$

$$\frac{d\beta}{dt} - 6h_0q_0\alpha - 6h_1q_0^2\alpha + h_2\alpha^3\lambda - h_3\alpha = 0, \tag{20d}$$

$$h_2\alpha^2\mu - 4h_1q_0q_1 - 2h_0q_1 = 0, \tag{20e}$$

$$h_2\alpha^2\nu - h_1q_1^2 = 0. \tag{20f}$$

Solving the system of algebraic equations, we would end up with the explicit pulse parameters for q_0, q_1, α and β , we obtain

$$q_0(t) = q_{00}e^{-A \int h_4 dt}, \tag{21a}$$

$$q_1(t) = q_{10}e^{-A \int h_4 dt}, \tag{21b}$$

$$\alpha(t) = \alpha_0 e^{-\int h_4 dt}, \tag{21c}$$

$$\beta(t) = \int (6h_0q_0\alpha + 6h_1q_0^2\alpha - h_2\alpha^3\lambda + h_3\alpha) dt + \beta_0, \tag{21d}$$

where q_{00}, q_{10}, α_0 and β_0 are the integration constants and are identified from initial data of the pulse. Notice that (20e) and (20f) serve as constraint relations between the coefficient functions and the pulse parameters.

From (20e) and (20f), one may find that

$$q_{00} - \frac{\mu}{4\nu}q_{10} = -\frac{h_0}{2h_1}e^{A \int h_4 dt}, \tag{22}$$

and

$$\frac{\alpha_0}{q_{10}} = \sqrt{\frac{h_1}{h_2\nu}} e^{(1-A) \int h_4 dt}, \tag{23}$$

$$h_1h_2\nu > 0,$$

which indicate that (22) and (23) must be satisfied to assure the existence and the formation process of soliton structures. Taking account of these data, we attain the exact solutions for Equation (12) as following

$$u_1(x, t) = e^{-A \int h_4 dt} \left(q_{00} + q_{10} \frac{2\lambda \operatorname{sech}(\sqrt{\lambda} \xi)}{\varepsilon \sqrt{\mu^2 - 4\lambda\nu} - \mu \operatorname{sech}(\sqrt{\lambda} \xi)} \right), \quad (24a)$$

$$\lambda > 0, \mu^2 - 4\lambda\nu > 0,$$

$$u_2(x, t) = e^{-A \int h_4 dt} \left(q_{00} + q_{10} \frac{2\lambda \operatorname{csch}(\sqrt{\lambda} \xi)}{\varepsilon \sqrt{4\lambda\nu - \mu^2} - \mu \operatorname{csch}(\sqrt{\lambda} \xi)} \right), \quad (24b)$$

$$\lambda > 0, \mu^2 - 4\lambda\nu < 0,$$

$$u_3(x, t) = e^{-A \int h_4 dt} \left(q_{00} + q_{10} \frac{-\lambda\mu \operatorname{sech}^2\left(\frac{\sqrt{\lambda}}{2} \xi\right)}{\mu^2 - \lambda\nu \left(1 + \varepsilon \tanh\left(\frac{\sqrt{\lambda}}{2} \xi\right)\right)^2} \right), \quad (24c)$$

$$\lambda > 0,$$

$$u_4(x, t) = e^{-A \int h_4 dt} \left(q_{00} - q_{10} \frac{\lambda}{\mu} \left[1 + \varepsilon \tanh\left(\frac{\sqrt{\lambda}}{2} \xi\right) \right] \right), \quad (24d)$$

$$\lambda > 0, \mu^2 = 4\lambda\nu,$$

where $(u_i(x, t) = U_i(t, \xi), i = 1, 2, 3, 4), \xi = \alpha(t)x + \beta(t)$ and $\varepsilon = \pm 1$.

We note that, Equation (18) admits several other types of solutions, it is easy to see that we can include more solutions as listed in Sirendaoreji (sire1), we omit these results here. The propagation velocity of the soliton pulse is related to parameters describing the process and is expressed by the relation $v(t) = \frac{d\beta(t)/\alpha(t)}{dt}$, and the inverse widths are given by $\alpha(t)\sqrt{\lambda}$ and $\alpha(t)\frac{\sqrt{\lambda}}{2}$, which exist provided $\lambda > 0$ for the wave solutions ((24a), (24b)) and ((24c), (25d)), respectively. All the solutions found have been verified through substitution with the help of Mathematica software. However, to our best knowledge, all solutions obtained are completely new except the solution 3 is just the result found by Triki et al. (2010) with a different route using directly the ansatz method.

A qualitative plot of the solution (24a), $u_1(x, t) = U_1(t, \xi)$ is presented in Figures 1 and 2 shows the physical wave (24d), $u_4(x, t) = U_4(t, \xi)$. It is apparent that the amplitude contributes to the formation of solitons mainly through the model function $h_4(t)$ (for full structures). Consequently, in the absence of the coefficient function $h_4(t)$, the partial and full structures become substantially equivalent versions.

Figure 1. The graph shows the wave solution of $u_1(x, t) = U_1(t, \xi)$ in Equation (24a). The curve, was performed with the parameters $A = 1, \mu = 4, \lambda = 1, \nu = 3, \varepsilon = 1, q_{00} = \frac{4}{3}, q_{10} = 1, \alpha_0 = \sqrt{\frac{2}{3}}, \beta_0 = 0, h_0 = 4, h_1 = -2t, h_2 = -t, h_3 = \frac{2}{t}, h_4 = t^{-1}$.

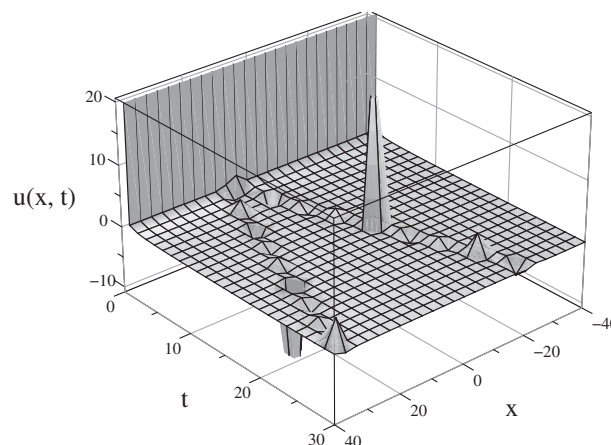
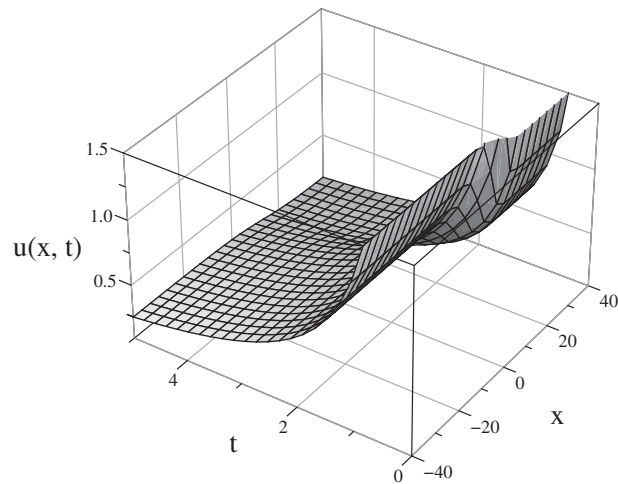

Figure 2. The evolution of the wave solution $u_4(x,t) = U_4(t, \xi)$ given by Equation (24d), input parameters: $A = 1, \mu = 4, \lambda = 1, \nu = 4, \varepsilon = 1, q_{00} = \frac{4}{3}, q_{10} = 1, \alpha_0 = \sqrt{\frac{1}{2}}, \beta_0 = 0, h_0 = 4, h_1 = -2t, h_2 = -t, h_3 = \frac{2}{t}, h_4 = t^{-1}$.



6. Conclusion

In this work, we applied a new analytical technique namely, the functional variable method (fvm) to establish some new exact analytic wave structures to the KdV–mKdV equation with time-dependent coefficients. On one side, for the first case study, we obtained the limited solutions using the partial structures for the function $h_4 = 0$. On the other side, for the second case study, we introduced the results obtained for the partial structures to solve the KdV–mKdV nonlinear differential equation for the full structures in the presence of the function $h_4 \neq 0$. Four variants of complete travelling wave solutions are obtained. The present method provides a reliable technique that requires less work if compared with the difficulties arising from computational aspect. The main advantage of this method is the flexibility to give exact solutions to nonlinear PDEs without any need for perturbation techniques, and does not require linearizing or discrediting. All calculations are performed using Mathematica.

We may conclude that, this method can be easily extended to find the solution of some high-dimensional nonlinear problems. These points will be investigated in a future research.

Acknowledgement

We want to thank Pr W. Higg and Dr J. Wang for their valuable comments.

Funding

This work is partially supported by M.E.R.S (Ministère de l'Enseignement et de la Recherche Scientifique) [PNR number 30/15/2011].

Author details

W. Djoudi¹

E-mail: w.djodi@gmail.com

A. Zerarka¹

E-mails: abzerarka@yahoo.fr, azerarka@hotmail.fr

¹ Laboratory of Applied Mathematics, University Med Khider, BP145, 07000 Biskra, Algeria.

Citation information

Cite this article as: Exact solutions for the KdV–mKdV equation with time-dependent coefficients using the modified functional variable method, W. Djoudi & A. Zerarka, *Cogent Mathematics* (2016), 3: 1218405.

References

Benjamin, R. T., Bona, J. L., & Mahony, J. J. (1972). Model equations for long waves in nonlinear dispersive systems. *Philosophical Transactions of the Royal Society London*, 272, 47–78.

- Dye, J. M., & Parker, A. (2000). An inverse scattering scheme for the regularized long-wave equation. *Journal of Mathematical Physics*, 41, 2889–2904.
- Fan, E., & Zhang, J. (2002). Applications of the Jacobi elliptic function method to special-type nonlinear equations. *Physics Letters A*, 305, 383–92.
- Freeman, N. C., & Johnson, R. S. (1970). Shallow water waves on shear flows. *Journal of Fluid Mechanics*, 42, 401–409.
- Hirota, R. (1971). Exact solution of KdV equation for multiple collisions of solitons. *Physical Review Letters*, 27, 1192–1194.
- Iskandar, L. (1989). New numerical solution of the Korteweg-de Vries equation. *Applied Numerical Mathematics*, 5, 215–221.
- Jinqueing, F., & Wei-Guang, Y. (1992). Adomian's decomposition method for the solution of generalized Duffing equations. In *Proceeding International Workshop on Mathematics Mechanization* (p. 1992), Beijing.
- Khelil, N., Bensalah, N., Saidi, H., & Zerarka, A. (2006). Artificial perturbation for solving the Korteweg-de Vries equation. *Journal of Zhejiang University SCIENCE A*, 7, 2079–2082.
- Korteweg, D.J., & de Vries, G. (1895). On the change of the form of long waves advancing in a rectangular canal and on a new type of long stationary waves. *Philosophical Magazine*, 39, 422–443.
- Li, X., & Wang, M. (2007). A sub-ODE method for finding exact solutions of a generalized KdV–mKdV equation with high-order nonlinear terms. *Physics Letters A*, 361, 115–118.

- Liu, J. B., & Yang, K. Q. (2004). The extended F-expansion method and exact solutions of nonlinear PDEs. *Chaos, Solitons & Fractals*, 22, 111–121.
- Malfliet, W. (1992). Solitary wave solutions of nonlinear wave equations. *American Journal of Physics*, 60, 650–654.
- Sirendaoreji (2004). New exact travelling wave solutions for the Kawahara and modified Kawahara equations. *Chaos, Solitons & Fractals*, 19, 147–150.
- Sirendaoreji (2007). Auxiliary equation method and new solutions of Klein—Gordon equations. *Chaos, Solitons & Fractals*, 31, 943–950.
- Triki, H., Thiab, T. R., & Wazwaz, A. M. (2010). Solitary wave solutions for a generalized KdV-mKdV equation with variable coefficients. *Mathematics and Computers in Simulation*, 80, 1867–1873.
- Wang, D.-S. & Li, H. (2008). Symbolic computation and non-travelling wave solutions of (2+1)-dimensional nonlinear evolution equations. *Chaos, Solitons & Fractals*, 38, 383–390.
- Wazwaz, A. M. (2002). New solitary-wave special solutions with compact support for the nonlinear dispersive K (m, n) equations. *Chaos, Solitons & Fractals*, 13(2), 321–30.
- Wazwaz, A. M. (2007a). Analytic study on nonlinear variants of the RLW and the PHI-four equation. *Communications in Nonlinear Science and Numerical Simulation*, 12, 314–327.
- Wazwaz, A. M. (2007b). Analytic study for fifth-order KdV-type equations with arbitrary power nonlinearities. *Communications in Nonlinear Science and Numerical Simulation*, 12, 904–909.
- Xu, L. P., & Zhang, J. L. (2007). Exact solutions to two higher order nonlinear Schrödinger equations. *Chaos, Solitons & Fractals*, 31, 937–42.
- Yomba, E. (2004). Construction of new soliton-like solutions for the (2+1) dimensional Kadomtsev-Petviashvili equation. *Chaos, Solitons & Fractals*, 22, 321–325.
- Yomba, E. (2005). The extended F-expansion method and its application for solving the nonlinear wave, CKGZ, GDS, DS and GZ equations. *Physics Letters A*, 340, 149–160.
- Zerarka, A. (1996). Solution of Korteweg-de Vries equation by decomposition method. *In International Congress on Applied Mathematics and Engineering Sciences*. Casablanca.
- Zerarka, A., & Foester, V.G. (2005). Separation method for solving the generalized Korteweg-de Vries equation. *Communications in Nonlinear Science and Numerical Simulation*, 10, 217–225.
- Zerarka, A., Ouamane, S., & Attaf, A. (2011). Construction of exact solutions to a family of wave equations by the functional variable method. *Waves in Random and Complex Media*, 21, 44–56.
- Zhou, Y., Wang, M., & Wang, Y. (2003). Periodic wave solutions to a coupled KdV equations with variable coefficients. *Physics Letters A*, 308, 3136.



© 2016 The Author(s). This open access article is distributed under a Creative Commons Attribution (CC-BY) 4.0 license.

You are free to:

Share — copy and redistribute the material in any medium or format
Adapt — remix, transform, and build upon the material for any purpose, even commercially.
The licensor cannot revoke these freedoms as long as you follow the license terms.

Under the following terms:

Attribution — You must give appropriate credit, provide a link to the license, and indicate if changes were made.
You may do so in any reasonable manner, but not in any way that suggests the licensor endorses you or your use.
No additional restrictions

You may not apply legal terms or technological measures that legally restrict others from doing anything the license permits.



Cogent Mathematics (ISSN: 2331-1835) is published by Cogent OA, part of Taylor & Francis Group.

Publishing with Cogent OA ensures:

- Immediate, universal access to your article on publication
- High visibility and discoverability via the Cogent OA website as well as Taylor & Francis Online
- Download and citation statistics for your article
- Rapid online publication
- Input from, and dialog with, expert editors and editorial boards
- Retention of full copyright of your article
- Guaranteed legacy preservation of your article
- Discounts and waivers for authors in developing regions

Submit your manuscript to a Cogent OA journal at www.CogentOA.com



New Exact Structures for the Nonlinear Lattice Equation by the Auxiliary Fractional Shape

DJOUDI W., DEBOWSKY G. and ZERARKA A.*

Labo of Applied Mathematics, University Med Khider BP145, 07000 Biskra; Algeria.

Received 23 June 2016; Accepted 23 August 2016

Abstract. In this paper, the auxiliary rational shape is successfully applied for obtaining new exact travelling solutions of the nonlinear lattice equation. These solutions include rational solutions, with periodic and doubly periodic wave profiles. Many new exact traveling wave solutions are successfully obtained.

AMS Subject Classifications: 35C07, 35C08

Chinese Library Classifications: O175.27

Key Words: Nonlinear lattice; travelling wave solutions.

1 Introduction

In recent decades, much progress has been made to study the systems of nonlinear partial differential equations. Because of its importance to the field of engineering and many physical systems, a great deal of methods and numerical calculations were appeared [1–6] to give different structures to the solutions. Besides traditional methods such as auto-Backlund transformation, Lie Groups, inverse scattering transformation and Miura's transformation, a vast variety of the direct methods for obtaining explicit traveling solitary wave solutions have been found [7–14].

The availability of symbolic computation packages can be facilitate many direct approaches to establish solutions to non-linear wave equations [15–23]. Various extension forms of the sine-cosine and tanh methods proposed by Malfliet and Wazwaz have been applied to solve a large class of nonlinear equations [24–27]. More importantly, another mathematical treatment is established and used in the analysis of these nonlinear problems, such as Jacobian elliptic function expansion method, the variational iteration method, pseudo spectral method, and many others powerful methods [28–39].

*Corresponding author. *Email addresses:* abzerarka@yahoo.fr (A. Zerarka), w.djodi@gmail.com (W. Djoudi), g_bowsky@outlook.fr (G. Debowsky)

The governing equation that studies the propagation of solitons is formulated through an nonlinear lattice. We expect that the presented method could lead to construct successfully many other solutions for a large variety of other nonlinear evolution equations. The prime motive of this work is to derive an effective auxiliary technique for a class of nonlinear model equations.

2 Mathematical formulation of the problem

The governing equation written in several independent variables is presented as

$$R(u, u_t, u_x, u_y, u_z, u_{xy}, u_{yz}, u_{xz}, u_{xx}, \dots) = 0, \tag{2.1}$$

where the subscripts denote differentiation, while $u(t, x, y, z, \dots)$ is an unknown function to be determined. Equation (2.1) is a nonlinear partial differential equation that is not integrable in general. Sometime it is difficult to find a complete set of solutions. If the solutions exist, there are many methods which can be used to handled these nonlinear equations.

The following transformation is used for the new wave variable as

$$\zeta = \sum_{i=0}^p \alpha_i \chi_i + \delta, \tag{2.2}$$

χ_i are distinct variables, and when $p=1$, $\zeta = \alpha_0 \chi_0 + \alpha_1 \chi_1 + \delta$, the quantities α_0, α_1 are called the wave pulsation ω and the wave number k respectively if χ_0, χ_1 are the variables t and x respectively. In the discrete case for the position x and with continuous variable for the time t , ζ becomes with some modifications $\zeta_n = nd + ct + \delta$ and n is the discrete variable. d and δ are arbitrary constants and c is the velocity.

We give the traveling wave reduction transformation for Eq. (2.1) as

$$u(\chi_0, \chi_1, \dots) = U(\zeta), \tag{2.3}$$

and the chain rule

$$\frac{\partial}{\partial \chi_i} (\cdot) = \alpha_i \frac{d}{d\zeta} (\cdot), \quad \frac{\partial^2}{\partial \chi_i \partial \chi_j} (\cdot) = \alpha_i \alpha_j \frac{d^2}{d\zeta^2} (\cdot), \dots \tag{2.4}$$

Upon using (2.3) and (2.4), the nonlinear problem (2.1) becomes an ordinary differential equation (ODE) like

$$Q(U, U_\zeta, U_{\zeta\zeta}, U_{\zeta\zeta\zeta}, U_{\zeta\zeta\zeta\zeta}, \dots) = 0. \tag{2.5}$$

3 Applications

The one-dimensional Hybrid-Lattice equation reads [40–45]

$$\frac{du(n,t)}{dt} - (\alpha + \beta u(n,t) + u^2(n,t)) [u(n+1,t) - u(n-1,t)] = 0. \quad (3.1)$$

We first combine the independent variables, into a wave variable using ξ_n as

$$\xi_n = nd + ct + \delta. \quad (3.2)$$

and we write the travelling wave solutions of the system (3.1) with (3.2) as $u(n,t) = U(\xi_n)$. By using the chain rule (2.4), the differential equation (3.1) can be transformed as:

$$cU_{\xi_n}(\xi_n) - (\alpha + \beta U(\xi_n) + U^2(\xi_n)) (U(\xi_{n+1}) - U(\xi_{n-1})) = 0, \quad (3.3)$$

in which, the subscript indicates the differential with respect to ξ_n .

4 The sin function method

Supposing Eq.(3.3) has the following solution:

$$U(\xi_n) = \frac{a + b \sin^2(\xi_n)}{j + \sin^2(\xi_n)}, \quad (4.1)$$

where a , b and j are coefficients to be determined later. In order to determine values of coefficients, we substitute the solution (4.1) into (3.1), and equating to zero the coefficients of all powers of $\sin(\xi_n)$, and the Mathematica software has been used for programming and computations to obtain the two travelling wave solutions of the problem of interest as

$$u_{\pm}(n,t) = U_{\pm}(\xi_n) = \frac{\frac{\beta}{2} \pm \sqrt{(\beta^2 - 4\alpha)(\sin^2(d) - \sin^4(d)) - \beta \sin^2(\xi_n)}}{-1 + 2\sin^2(\xi_n)}, \quad (4.2)$$

and the wave variable is found as

$$\xi_n = nd - \frac{1}{2}(\beta^2 - 4\alpha) \cos(d) \sin(d) t + \delta. \quad (4.3)$$

5 The sinh function method

Now we seek the solution as

$$U(\xi_n) = \frac{a + b \sinh^2(\xi_n)}{j + \sinh^2(\xi_n)}. \quad (5.1)$$

Substituting the solution (5.1) into (3.1), and equating to zero the coefficients of all powers of $\sinh^j(\xi_n)$ yields a set of algebraic equations for a , b and j , and the two travelling wave solutions of the problem of interest are

$$u_{\pm}(n,t) = U_{\pm}(\xi_n) = \frac{\frac{\beta}{2} \pm \sqrt{(\beta^2 - 4\alpha) (\sinh^2(d) - \sinh^4(d)) - \beta \sinh^2(\xi_n)}}{-1 + 2\sinh^2(\xi_n)}, \quad (5.2)$$

where the wave variable is found to be

$$\xi_n = nd - \frac{1}{2}(\beta^2 - 4\alpha) \cosh(d) \sinh(d)t + \delta. \quad (5.3)$$

6 The cosh function method

Now, the general solutions can be written in terms of cosh function in the form

$$U(\xi_n) = \frac{a + b \cosh^2(\xi_n)}{j + \cosh^2(\xi_n)}. \quad (6.1)$$

Substituting these solutions into the relevant nonlinear differential equation (3.1) and solving the resulting system with the help of Mathematica gives the two travelling wave solutions as

$$u_{\pm}(n,t) = U_{\pm}(\xi_n) = \frac{\frac{\beta}{2} \pm \sqrt{(\beta^2 - 4\alpha) (\cosh^2(d) - \cosh^4(d)) - \beta \cosh^2(\xi_n)}}{-1 + 2\cosh^2(\xi_n)}, \quad (6.2)$$

where

$$\xi_n = nd - \frac{1}{2}(\beta^2 - 4\alpha) \cosh(d) \sinh(d)t + \delta. \quad (6.3)$$

7 The cn function method

We consider now, the Jacobian elliptic function cn to describe doubly periodic wave solutions,

$$U(\xi_n) = \frac{a + b \text{cn}^2(\xi_n, m)}{j + \text{cn}^2(\xi_n, m)}, \quad (7.1)$$

where a , b and j are constants to be determined later, and m is a modulus of Jacobi elliptic function. If $m = 0$, $\text{cn}(\xi_n, 0) = \cos(\xi_n)$, becomes localized soliton solutions, and if $m = 1$, $\text{cn}(\xi_n, 1) = \text{sech}(\xi_n)$. The result for $m = 0$ is similar to the \sin function with the following mapping: $\sin \rightarrow \cos$ and $\xi_n \equiv \xi_n$. The case $m = 1$ is not treated here.

Remark 7.1. We note that there is no imposed restriction on $u(n,t)$ because the β and α parameters contribute in a similar way in the construction of solutions provided that the term $\frac{(\beta^2 - 4\alpha)}{\cosh^2(d) - \cosh^4(d)}$ must be positive. It follows from (6.3) that the propagation velocity of the localized lattice wave is related to parameters β , α and d describing the process and is expressed by the relation as

$$c = \frac{(\beta^2 - 4\alpha) \cosh(d) \sinh(d)}{2d}, \tag{7.2}$$

such a real lattice wave exists, provided $\beta > 2\sqrt{\alpha}$. This lattice problem leads to indicate that from the above analysis, all solutions are of compression waves type. The solution reduces to a localised form in a particular position nd when $\beta = \pm 2\sqrt{\alpha}$ and the velocity becomes zero. For more information about the existence of solitary waves on lattices for a wider classes of systems lattice, the reader is referred to [49-50]. We conclude by adding an important observation regarding the nature of solutions: The profiles of all structures obtained from above ansatz are equivalent through the amplitude and the velocity in changing the principal function in each case.

Physically, these solutions represent waves propagating in the positive nd direction with constant speed c without change of shape as shown in Fig. 1, given by $u_+(n,t) = U_+(\xi_n)$ (4.2), and the solution $u_+(n,t) = U_+(\xi_n)$ (5.2) is displayed in Fig. 2. The plot of the third structure is depicted in Fig. 3

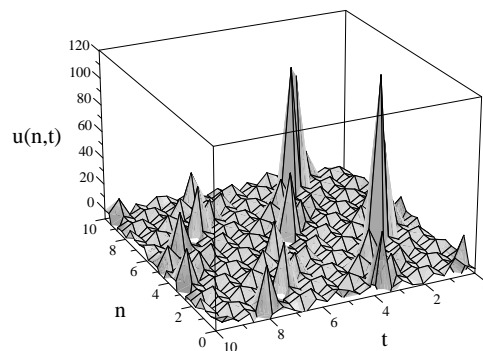

Figure 1: The graph shows the wave solution of $u_+(n,t) = U_+(\xi_n)$ in (4.2): The curve, was performed with the parameters $\alpha = d = 1$, $\beta = 4$, $\delta = 0$.

Remark 7.2. A novel class of explicit exact solutions to nonlinear equations can be derived from an extended auxiliary fractional shape (Exafs) using a non-singular combination of these functions as

$$U(\xi) = \frac{\alpha_0 + \sum_{k=1}^M \alpha_k F^k(\xi)}{F^{M/2}(\xi)}, \tag{7.3}$$

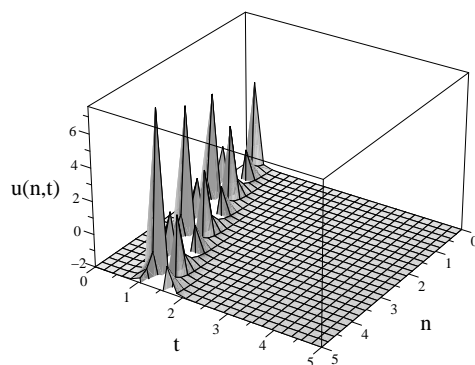

Figure 2: The graph shows the wave solution in (5.2) $u_+(n,t) = U_+(\xi_n)$. The curve, was performed with the parameters $\alpha = d = 0.5$, $\beta = 4$, $\delta = 0$.

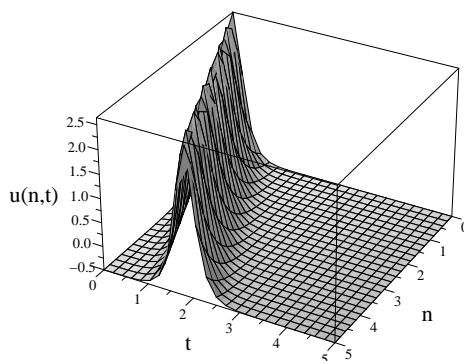

Figure 3: The graph shows the wave solution in (6.2) $u_+(n,t) = U_+(\xi_n)$. The curve, was performed with the parameters $\alpha = \beta = d = 1$, $\delta = 0$.

where F are functions of the same category and can be expressed in terms of any trigonometric functions, hyperbolic functions, Jacobi elliptic function, or Weierstrass elliptic functions. The constant M is deduced from the homogeneous balance method in the nonlinear wave equation in question. The complete formulation and some applications of the (Exafs) will be given in a subsequent paper.

8 Conclusion

In summary, we applied a new trial travelling solution to find out several exact solutions to the nonlinear lattice equation. All solutions obtained are completely found with a different route using directly the ansatz method. However, to our best knowledge, all solutions obtained are new, and all the solutions found have been verified through substitution with the help of Mathematica software.

Four types of functions are used to find the exact solutions, which are named the

sin-function, the sinh function, the cosh function and the cn function. These functions are taken as primary profile to construct the auxiliary fractional shape. The modified auxiliary fractional shape formulation plays an important part for finding the analytic solution of problems which may be useful to further describe the mechanisms of the complicated nonlinear phenomena. The basic idea of this approach can be further used to solve other strongly non-linear situations. It will be then interesting to study more general systems. This direction of inquiry is under considerations and is envisioned for a sequel to this paper.

Acknowledgment

One of us (A. Z.) gratefully acknowledges support by M.E.R.S (Ministère de l'Enseignement et de la Recherche Scientifique): PNR no 30/15/2014.

References

- [1] Wang D.-S. and Li H., Symbolic computation and non-travelling wave solutions of (2+1)-dimensional nonlinear evolution equations. *Chaos, Solitons and Fractals*, **38** (2008), 383-390.
- [2] Korteweg D. J. and Vries G. de, On the change of the form of long waves advancing in a rectangular canal and on a new type of long stationary waves. *Philos. Mag.*, **39** (1895), 422C443.
- [3] Freeman N. C. and Johnson R. S., Shallow water waves on shear flows. *J. Fluid. Mech.*, **42** (1970), 401-409.
- [4] Zerarka A., Solution of Korteweg-de Vries equation by decomposition method. *Internat. Cong. on Math. Appl. and Ingeen. Sc, Casa*, (1996), 241-245.
- [5] Sirendaoreji NA., Auxiliary equation method and new solutions of Klein-Gordon equations. *Chaos, Solitons & Fractals*, **31** (2007), 943-950.
- [6] Zhang Huiqun, New exact Jacobi elliptic function solutions for some nonlinear evolution equations. *Chaos, Solitons & Fractals*, **32** (2) (2007), 653-660.
- [7] Ablowitz MJ, Clarkson PA. *Soliton, Nonlinear Evolution Equations and Inverse Scattering*. New York: Cambridge University Press, 1991.
- [8] Khelil N., Bensalah N., Saidi H. and Zerarka A., Artificial perturbation for solving the Korteweg-de Vries equation. *J. Zhejiang Univ SCIENCE A*, **7** (12) (2006), 2079-2082.
- [9] Zerarka A. and Foester V. G., Separation method for solving the generalized Korteweg –de Vries equation. *Comm. Nonl. Sc. Num. Sim.*, **10** (2005), 217-225.
- [10] Yajima T. and Wadati M., Soliton Solution and Its Property of Unstable Nonlinear Schrodinger Equation. *J. Phys. Soc. Jpn.*, **59** (1990), 41-47.
- [11] EI-Kalaawy OH., Exact soliton solutions for some nonlinear partial differential equations. *Chaos, Solitons & Fractals*, **14** (4) (2002), 547-552.
- [12] Wazwaz AM., New solitary-wave special solutions with compact support for the nonlinear dispersive K (m, n) equations. *Chaos, Solitons & Fractals*, **13** (2) (2002), 321-30.
- [13] Sasamoto T. and Wadati M., Determinant form solution for the derivative non-linear Schrodinger type model. *J. Phys. Soc. Jpn.*, **67** (1998), 784-790.

- [14] Ibrahim R. S., El-Kalaawy O. H., Extended tanh-function method and reduction of nonlinear Schrödinger-type equations to a quadrature. *Chaos, Solitons & Fractals*, **31** (4) (2007), 1001-1008.
- [15] Hirota R., Exact solution of KdV equation for multiple collisions of solitons. *Phys. Rev. Lett.* **27** (1971), 1192-1194.
- [16] Iskandar L., New numerical solution of the Korteweg-de Vries equation. *Appl. Num. Math.* **5** (1989), 215-221.
- [17] Xu L. P., Zhang J. L. Exact solutions to two higher order nonlinear Schrödinger equations. *Chaos, Solitons & Fractals*, **31** (2007), 937-942.
- [18] Jinqing F. and Guang Y. Wei, Adomian's decomposition method for the solution of generalized Duffing equations. *In Proc.*, (1992), Internat. Workshop on Mathematics Mechanization, Blijing China, (1992), 231-235.
- [19] Scott A. C., Chu E. Y. F. and McLaughlin D. W., The soliton: A new concept in applied science. *Proc. of IEEE.*, **61** (1973), 1443-1483.
- [20] Gardner C. S., Green J. M., Kruskal M. D., and Miura R. M., Method for solving the KdV equation. *Phys. Rev. Lett.*, **19** (1967), 1095-1097.
- [21] Özis T., Yildırım A., Reliable analysis for obtaining exact soliton solutions of nonlinear Schrödinger (NLS) equation. *Chaos, Solitons and Fractals*, **38** (2008), 209-212.
- [22] Zakharov V. E. and Shabat A. B., Exact theory of two-dimensional self-focusing and one-dimensional waves in non-linear media. *Sov. Phys. JETP*, **34** (1972), 62-69.
- [23] Zhou Yubin, Wang Mingliang, Wang Yueming, Periodic wave solutions to a coupled KdV equations with variable coefficients. *Phys. Lett. A*, **308** (2003), 31-36.
- [24] Malfliet W. Solitary wave solutions of nonlinear wave equations. *Am. J Phys.*, 1992; **60** (7) (1992), 650-654.
- [25] Malfliet W., The tanh method: I. Exact solutions of nonlinear evolution and wave equations. *Phys. Scr.*, 1996; **54** (1996), 563-568.
- [26] Malfliet W., The tanh method: II. Perturbation technique for conservative systems. *Phys. Scr.*, **54** (1996), 569-575.
- [27] Wazwaz AM., The tanh method for travelling wave solutions of nonlinear equations. *Appl. Math. Comput.*, **154** (3) (2004), 713-723.
- [28] Li J, Liu Z., Smooth and non-smooth travelling waves in a nonlinearly dispersive equation. *Appl. Math. Modell.*, **25** (2000), 41-56.
- [29] Shen JW, Xu W., Travelling wave solutions of Hirota-Satsuma system. *Appl. Math. Comput.*, **161** (2) (2005), 365-383.
- [30] He J. H., Wu X. H., Exp-function method for nonlinear wave equations. *Chaos, Solitons & Fractals*, **30** (3) (2006), 700-708.
- [31] He J. H., Wu X. H., Construction of solitary solution and compacton-like solution by variational iteration method. *Chaos, Solitons & Fractals*, **29** (1) (2006), 108-113.
- [32] Odibat ZM and Momani S., Application of variational iteration method to nonlinear differential equations of fractional order. *Int. J. Nonlinear Sci. Numer. Simul.*, **7** (1) (2006), 27-34.
- [33] He JH., Homotopy perturbation method for bifurcation of nonlinear problems. *Int. J. Nonlinear Sci. Numer. Simul.*, **6** (2) (2005), 207-208.
- [34] Rafei M, Ganji DD., Explicit solutions of Helmholtz equation and fifth-order KdV equation using homotopy perturbation method. *Int. J. Nonlinear Sci. Numer. Simul.*, **7** (3) (2006), 321-328.
- [35] Jianbin Liu, Lei Yang, Yang Kongqing, Jacobi elliptic function solutions of some nonlinear

- PDEs. *Phys. Lett. A*, **325** (3-4) (2004), 268-775.
- [36] Fan Engui, Zhang Jian, Applications of the Jacobi elliptic function method to special-type nonlinear equations. *Phys. Lett. A*, **305** (6) (2002), 383-392.
- [37] Yomba E., The extended F-expansion method and its application for solving the nonlinear wave, CKGZ, GDS, DS and GZ Equations. *Phys Lett A.*, **340** (2005), 149-160.
- [38] Liu J. B. and Yang K. Q., The extended F-expansion method and exact solutions of nonlinear PDEs. *Chaos, Solitons and Fractals*, **22** (2004), 111-121.
- [39] He JH., Some asymptotic methods for strongly nonlinear equations. *Int. J. Mod. Phys. B*, **20** (10) (2006), 1141-1199.
- [40] Wu Chufen and Weng Peixuan, New exact solutions for a nonlinear Lattice equation. *South-east Asian Bulletin of Mathematics*, **33** (2009), 587-596
- [41] Yu Y. X., Rational formal solutions of hybrid lattice equation. *Appl. Math. Comput.*, **186** (2007), 474-482.
- [42] Zhang S. Q., A new expanded method for solving nonlinear differential-difference equation. *J. Shanghai Jiaotong Univ.*, (2008) 13: 509C512.
- [43] Zhu S. D., Exp-function method for the hybrid-lattice systems. *Int. J. Nonlinear Sci. Numer. Simul.*, **8** (2007), 461-464.
- [44] Zhu S. D., Exp-function method for the discrete mkdv lattice. *Int. J. Nonlinear Sci. Numer. Simul.*, **8** (2007), 465-468.
- [45] Zhu S. D., Discrete (2+1)-dimensional toda lattice equation via exp-function method. *Phys. Lett. A*, **372** (5) (2008), 654-657.
- [46] Wazwaz AM., Analytic study on nonlinear variants of the RLW and the PHI-four equation. *Communications in Nonlinear Science and Numerical Simulation*, **12** (2007), 314-327.
- [47] Dye JM, Parker A. An inverse scattering scheme for the regularized long-wave equation. *J. Math. Phys.*, **41** (5) (2000), 889-904.
- [48] Benjamin RT, Bona JL, Mahony JJ., Model equations for long waves in nonlinear dispersive systems. *Philos Trans Roy Soc London*, **272** (1972), 47-78.
- [49] Scott A.C., *Nonlinear Science*, 2nd edition, Oxford University Press, Oxford, 2003.
- [50] Biondini G. and Wang D., On the soliton solutions of the two-dimensional Toda Lattice. *J. Phys. A, Math. Theor.*, **43** (43) (2010), 1-20.

ملخص

يهدف هذا العمل الى تحديد سلوك الحل الموجي في ظل اللاخطية بمساهمة مبدأ التوازن المتجانس و أساليب التحليل. قمنا في المرحلة الأولى بدراسة المعادلة اللاخطية للشبكة الذرية بتطبيق طريقة coth وطريقة coth-csch تحصلنا على ثمانية حلول جديدة لانتقال الموجة . وفي نفس السياق، تم إدخال طريقة التحويلات الكسرية و التي أعطت مختلف حلول دقيقة. أما في المرحلة الثانية طبقنا طريقة المتغير الوظيفي (الضمني) على مجموعة من المعادلات اللاخطية ل BBM ذات المعاملات الثابتة ومعادلة Kdv-mKdv المعممة ذات المعاملات المتغيرة.

الكلمات المفتاحية: معادلات اللاخطية، مبدأ التوازن، طريقة التحويلات الكسرية، طريقة المتغير الوظيفي (الضمني).

Abstract

This work aims to determine the behavior of wave solution under the effect of nonlinearity with the contribution of the homogeneous balance principle and analysis methods. In the first step we studied the nonlinear atomic lattice equation via the coth and coth-csch methods. Eight new travelling wave solutions have been obtained. In the same context, the method of fractional transformations is introduced and which has provided various exact solutions. In the second step we applied the functional variable method to a set of nonlinear BBM equations of constant coefficients and the general equation Kdv-mKdv of variable coefficients.

Keywords: The nonlinear equations, the homogeneous balance principle, the fractional transformations methods, functional variable method.

Résumé

Ce travail vise à déterminer le comportement des solutions d'onde sous l'effet de la non linéarité avec la contribution du principe d'équilibre homogène et les formes d'analyses. Dans la première étape de ce travail nous avons étudié en premier lieu l'équation non linéaire d'un réseau d'atomes en appliquant les méthodes coth et coth-csch. On a obtenu huit nouvelles solutions du déplacement d'onde. Dans le même contexte, la méthode des transformations fractionnelles est introduite et qui a fournit diverses solutions exactes. Dans la deuxième étape nous avons appliqué la méthode de la variable fonctionnelle sur un ensemble d'équations non linéaires de BBM de coefficients constants et l'équation générale Kdv-mKdv de coefficients variables.

Mots-clés: Equations non-linéaires, principe de l'équilibre homogène, méthodes des transformations fractionnelles, méthode de la variable fonctionnelle.